

SWIMMING POOLS

LIBRO DE PISCINAS
POOLS BOOK
LIVRE DE PISCINES

 30 years
moulding
the future
apegrupo

public & private swimming pools

piscinas públicas y privadas

30 years moulding the future

30 años moldeando el futuro

We open a new chapter in our history: this 2022 becomes special thanks to our 30th anniversary. We arrived at that moment as the leading company in the creation of differentiated spaces, where the design of our products and personalized service are the key to our growth.

A goal as important as it is difficult to achieve in these times, but which wouldn't have been possible without our teams, clients, suppliers and collaborators. A shared satisfaction with all the parties that make the perfect mix possible.

At this point, we have an eye on tomorrow to continue discovering emerging trends and listening to a world in constant evolution. Our purpose is to know, learn and add. Being able to tackle any challenge with perspective and knowledge to provide a valuable solution.

It is a year of future, of looking forward, of embracing new currents and of digital transformation. We reconvert ourselves to continue on the right path, working on strategies for the future, implementing new tools and technology to be ever closer to our audiences, our environment and the sector.

Abrimos un nuevo capítulo en nuestra historia: este 2022 se vuelve especial gracias a nuestro 30 aniversario. Llegamos a ese momento como la compañía líder en la creación de espacios diferenciados, donde el diseño de nuestros productos y el servicio personalizado son la clave de nuestro crecimiento.

Una meta tan importante como difícil de alcanzar en los tiempos que corren, pero que no hubiera sido posible sin nuestros equipos, clientes, proveedores y colaboradores. Una satisfacción compartida con todas las partes que hacen posible la mezcla perfecta.

Llegados a este punto, ponemos la mirada en el mañana, en seguir descubriendo tendencias emergentes y escuchar a un mundo en constante evolución. Nuestro propósito es conocer, aprender y sumar. Ser capaces de abordar cualquier desafío con perspectiva y conocimiento para aportar una solución de valor.

Es un año de futuro, de mirar hacia delante, de abrazar nuevas corrientes y de transformación digital. Nos reconvertimos para seguir por el buen camino, trabajando en estrategias de futuro, implementando nuevas herramientas y tecnología para estar cada vez más cerca de nuestros públicos, de nuestro entorno y del sector.

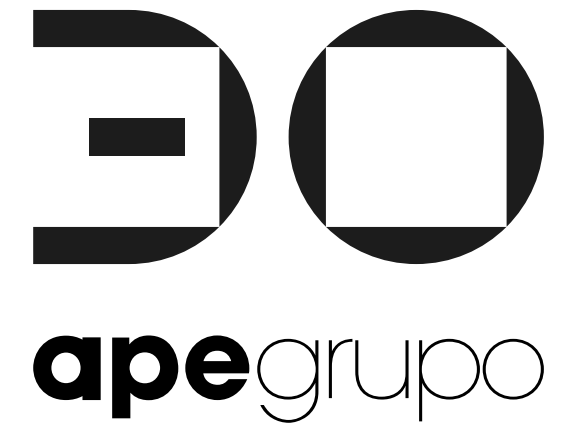



index

índice

PRIVATE POOLS / PISCINAS PRIVADAS

19

4.Stones
Alabama
Burlington
Cross
Deep Blue
Himalayas
Illinois
Koen
Oregon
Oxford
Pierre de Bali
Triana
Vita
Wabi Sabi
Work

PUBLIC POOLS / PISCINAS PÚBLICAS

150

Dots
Grooved

TECHNICAL INFORMATION / INFORMACIÓN TÉCNICA

162

Resistant by nature

Resistente por naturaleza

LIFETIME MATERIALS

Pools have characteristics that require a series of solutions unthought of in other architectural fields. The continuous contact with water, the crossing of bare feet and the existing complex regulatory framework related to hygiene and safety demand design competences obtained through a specific experience in the field.

That is why our ceramic collections are composed of porcelain pieces and special extruded stoneware pieces that allow us to create public and private pool projects, providing with multiple solutions and making the interior of our spaces coexist perfectly with the pool.

ES PARA TODA LA VIDA

Las características de las piscinas requieren una serie de soluciones que no se plantean en otros ámbitos arquitectónicos. El contacto continuo con el agua, el tránsito con pies descalzos y el complejo entramado normativo existente relativo a la higiene y la seguridad exigen competencias proyectuales que se obtienen mediante una experiencia específica en el campo.

Por este motivo nuestras colecciones cerámicas están compuestas de piezas de porcelánico y piezas especiales de gres extrusionado que nos permiten realizar proyectos de piscinas de ámbito público y privado aportando diversas soluciones y haciendo que el interior de nuestros espacios convivan a la perfección con la piscina.

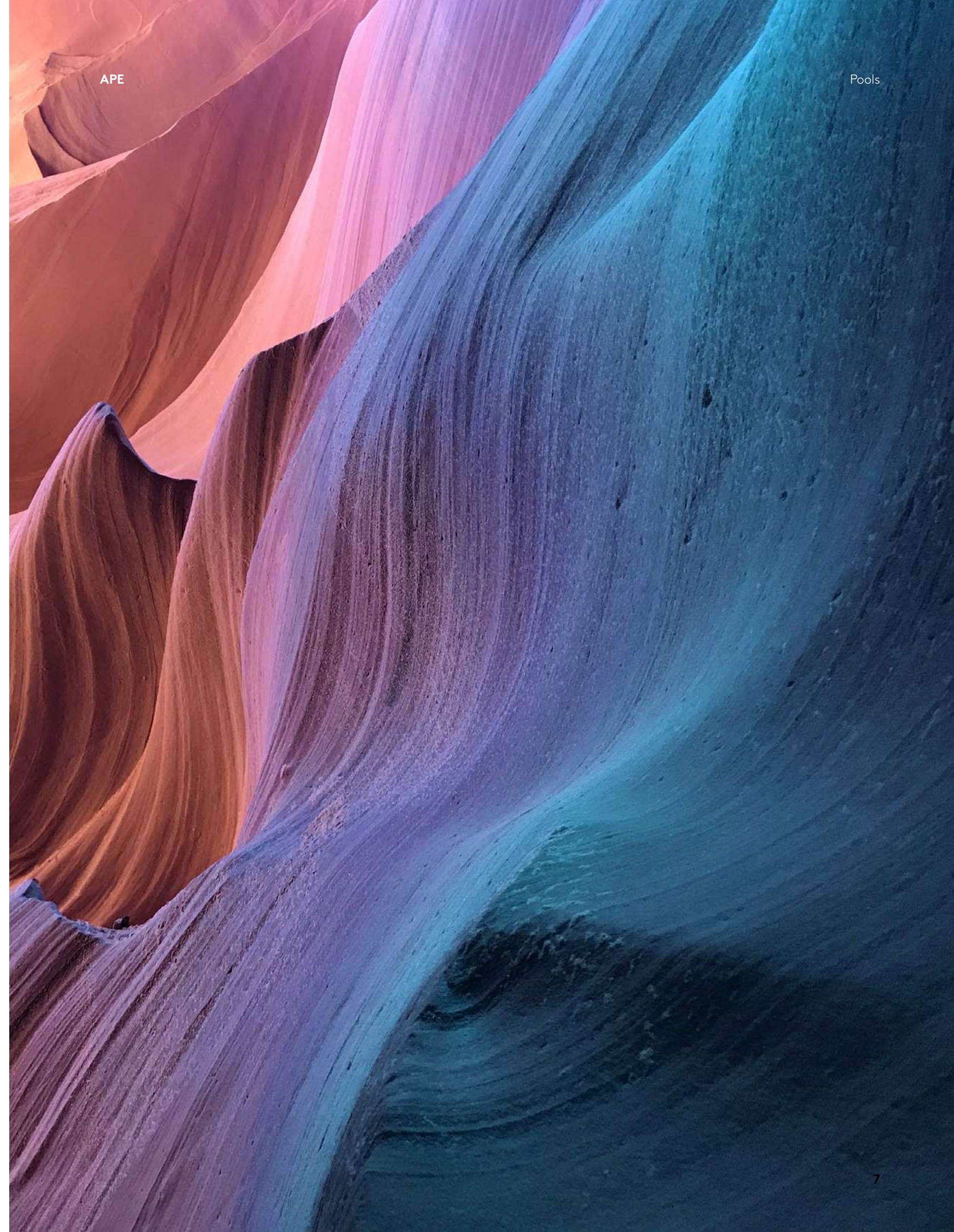

In communion with nature

En comunión con la naturaleza

APE

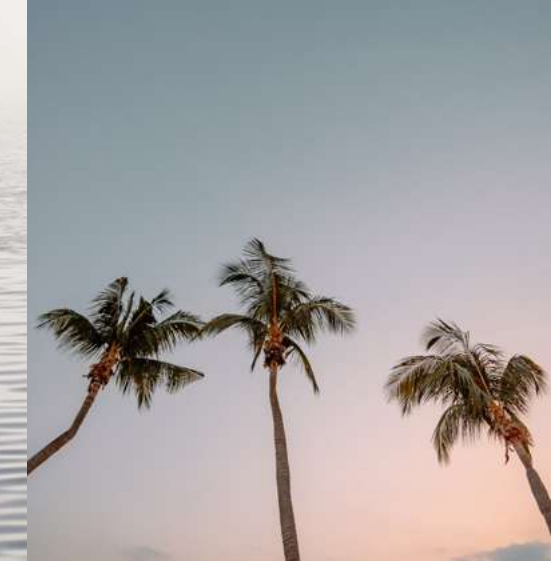
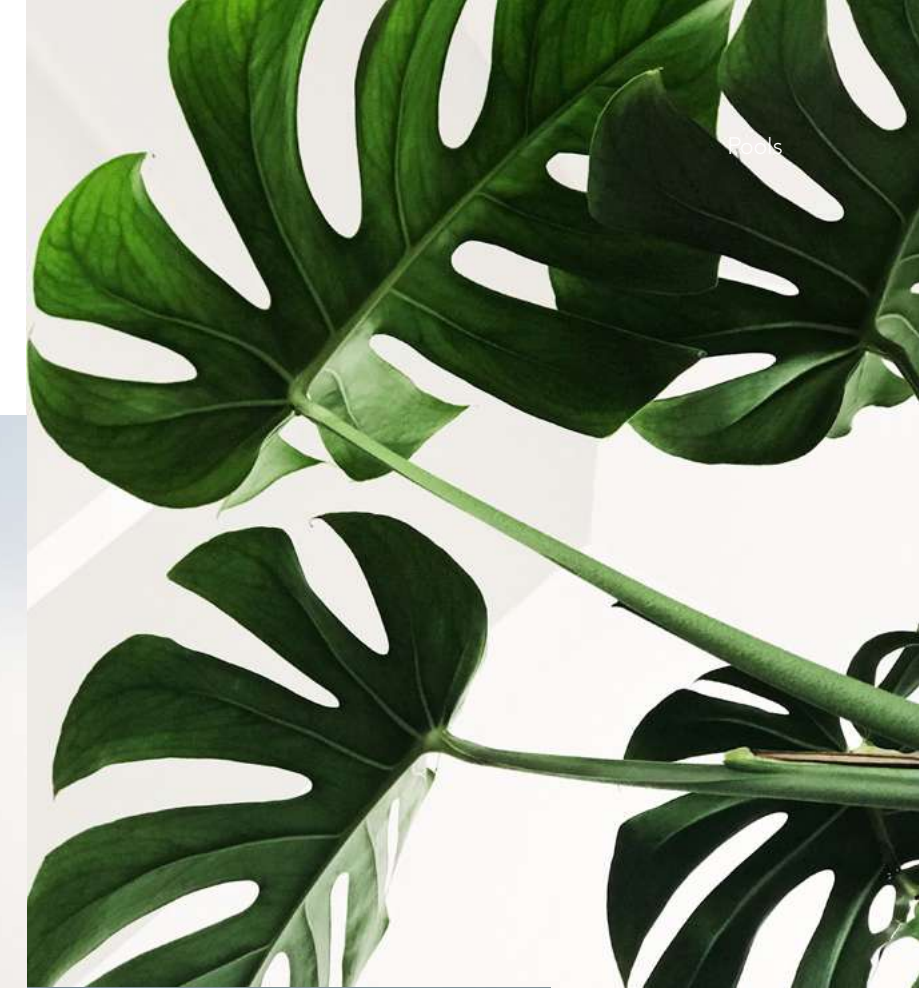

A UNIQUE EXPERIENCE

What is the pool of your dreams like?

When conceiving the construction of a pool, we must take into account that it is a fun and recreational area with maximum safety. That is why we must have pieces that not only guarantee quality and security, but also provide the swimming pool with a touch of beauty.

Limitless, with sights to the sea, in the middle of a garden, in a spa... No matter what the swimming pool of your dreams is like, all pools are a place to enjoy yourself, do some sport or relax. We take this into account when elaborating our product offer.

UNA EXPERIENCIA ÚNICA

¿Cómo es la piscina de tus sueños?

Cuando se proyecta la construcción de una piscina se debe tener en cuenta que es un área de diversión y esparcimiento con la máxima seguridad. Es por ello que se debe contar con piezas que garanticen la calidad y seguridad, pero también que aporten un plus de belleza.

Sin límites, con vistas al mar, en medio del jardín, en un spa, sea cuál sea y cómo sea la piscina de tus sueños, todas ellas son un lugar en el que disfrutar, hacer deporte o desconectar. Esto es tenido en cuenta a la hora de elaborar la oferta de productos de la firma.



Pools

APE offers two types of systems for the construction of private pools: the traditional pool with skimmers and the overflow pool.

APE ofrece dos tipos de sistemas para la construcción de piscinas privadas: la piscina tradicional con skimmer y la piscina de coronación desbordante.



TRADITIONAL POOL/PISCINA TRADICIONAL



OVERFLOW POOL/PISCINA DESBORDANTE

TRADITIONAL POOL

Basic, or traditional, pools with skimmer system are those in which the water level is 20 centimeters below the edges and can have rectangular, irregular or mixed form.

PISCINA TRADICIONAL

La piscina básica o tradicional con sistema skimmer es aquella en la que el nivel del agua se sitúa a unos 20 centímetros por debajo de los bordes y puede tener forma rectangular, irregular o mixta.

OVERFLOW POOL

Infinity pools have the water at the same level as the superior part of the terrace. Water laps at and spills over the pool's perimeter edge, obtaining a beautiful, attractive and unique visual effect.

PISCINA DESBORDANTE

La piscina desbordante es la que tiene el agua al mismo nivel que la parte superior de la playa. El agua rebosa el borde perimetral de la piscina consiguiendo un gran atractivo estético y un efecto visual inigualable.

Natural elegance

Elegancia natural



Pools

Which style do you want to give to your pool? Classic, cosmopolitan, Ibiza, Provence, minimalist, zen, contemporary, chic, bohemian... Explore all the colors and combinations and customize your design.

¿Qué estilo quieres darle a tu piscina? Clásico, cosmopolita, ibicenco, provenzal, minimalista, zen, contemporáneo, chic, bohemio. Explora todos los colores y combinaciones y personaliza tu diseño.

A PORCELAIN STONEWARE POOL

APE's porcelain satisfies the criteria of an innovative architecture and joins aesthetics with advanced technological performances.

It is anti-slip and resistant to abrasion, fire and contact with water, as well as chemical products. It is, therefore, the ideal material for public and residential environments. Moreover, it guarantees a perfect inalterability to the passing of time and, thanks to digital technology, has multiple designs inspired by marble, wood, stone or concrete, which respond to any aesthetic need.

A EXTRUDED STONEWARE POOL

The porcelain offer is complemented with a series of extruded stoneware ceramic pieces. Pieces that resolve both aesthetic and, technically, any type of environment. They stand out for their quality, durability and variety. They also are easy to maintain and resistant to chemical agents. In addition, they are highly anti-slip, since they are also conceived for covering the swimming pool perimeter.

Top pieces, such as mesh strainers, flashings or steps, are placed here. These pieces constitute a perfect covering both for the swimming pool tank and perimeter of public and private spaces.

UNA PISCINA DE GRES PORCELÁNICO

El porcelánico de APE satisface los criterios de una arquitectura innovadora y aúna estética con altas prestaciones tecnológicas.

Es antideslizante, resistente a la abrasión, al fuego y al contacto con el agua así como a los productos químicos. Es, por tanto, el material idóneo para ambientes residenciales y públicos. Además, garantiza una óptima inalterabilidad al paso del tiempo y gracias a la tecnología digital cuenta con diseños variados inspirados en el mármol, las maderas, piedras o cementos que responden a cualquier necesidad estética.

UNA PISCINA DE GRES EXTRUIDO

La oferta de porcelánico se complementa con una serie de piezas cerámicas en gres extruido. Piezas que solucionan tanto estética como técnicamente cualquier tipo de entorno y que se caracterizan por su calidad y durabilidad, variedad, fácil mantenimiento y resistencia a los agentes químicos. Además al ser piezas pensadas también para recubrir la playa de la piscina son altamente antideslizantes.

Se sitúan aquí piezas de coronación, rejillas, vierteaguas, peldaño... piezas que constituyen un recubrimiento ideal para el vaso como la playa de la piscina de espacios hídricos públicos o privados.



01_



02_



03_



04_



05_

- 01_ OREGÓN
- 02_ WORK
- 03_ OXFORD
- 04_ PIERRE DE BALI
- 05_ OXFORD

What color will my pool water look like?

The blue shade for the pool seems an obvious choice if we want the water to look this color too. But nothing could be more untrue. There are other options to achieve other shades such as turquoise or sky blue.

¿De qué color se verá el agua de mi piscina?

El tono azul para la piscina parece una elección obvia si queremos que el agua también se vea de este color. Pero nada más lejos de la realidad. Existen otras opciones que permiten conseguir otros tonos como los turquesas o los tonos azul cielo.

WHY DOES WATER LOOK BLUE IF IT IS TRANSPARENT?

Basically, water absorbs long light wavelengths - red, orange or yellow - and reflects short light wavelengths, such as blue. That bouncing color is what you actually see in water. It is therefore an optical effect that depends on the light, so the color changes depending on whether the pool is indoors or outdoors, whether it is day or night, or whether it is lit up.

¿POR QUÉ EL AGUA SE VE AZUL SI ES TRANSPARENTE?

Básicamente el agua absorbe las longitudes de luz de onda larga — rojo, naranja o amarillo — y refleja las de onda corta, como los azules. Ese color que rebota es precisamente el que se ve en el agua. Se trata pues de un efecto óptico que depende de la luz, por lo que el color varía en función de si la piscina es interior o exterior, si es de día o de noche o si está iluminada.

WHAT RESULTS WILL I GET WITH EACH COLOR?

White shades, such as white ceramic marble, achieve an intense Caribbean blue that will give you a fresh, tropical look. In contrast, intense brown and earth shades will produce a very interesting greenish effect. Light beiges, typical of natural ceramic stone, can help us create turquoise shades. And with grays, as they are neutral, an intense and dark blue shade is achieved. In addition, grays help to conceal the dust and impurities that accumulate at the bottom of the pool.

¿QUÉ RESULTADOS CONSEGUIRÉ CON CADA COLOR?

Los **tonos blancos**, como el mármol blanco cerámico, consiguen un azul intenso caribeño que le dará un aspecto tropical y fresco. Por el contrario los **tonos marrones y tierra** intensos harán un efecto verdoso muy interesante. Los **beiges claros** propios de la piedra natural cerámica, nos pueden ayudar a crear tonos turquesas. Y con los **grises**, al ser neutros, se consigue un tono azul intenso y oscuro. Además los grises ayudan a disimular el polvo e impurezas que se acumulan en el fondo de la piscina.



- 01_ BLANCOS
- 02_ MARRON
- 03_ BEIGE CLARO
- 04_ GRIS

symbolology

simbología

- | | |
|--|---|
| P PORCELÁNICO/PORCELAIN TILES | N EXTRUSIONADO/EXTRUDED |
| PR PASTA ROJA/RED BODY | C0 CLASE 0/CLASS 0 |
| PB PASTA BLANCA/WHITE BODY | C1 CLASE 1/CLASS 1 |
| RT REVESTIMIENTO/WALL TILE | C2 CLASE 2/CLASS 2 |
| FT PAVIMENTO/FLOOR TILES | C3 CLASE 3/CLASS 3 |
| B BRILLO/SHINE | R9 ANTI-SLIP R9 |
| M MATE/MATT | R10 ANTI-SLIP R10 |
| S SATINADO/SATIN | R11 ANTI-SLIP R11 |
| SP PULIDO BRILLO/SHINE POLISHED | R12 ANTI-SLIP R12 |
| MP PULIDO MATE/MATT POLISHED | AB ANTI-SLIP BAREFOOT A+B |
| LA LAPATTO/LAPPED | ABC ANTI-SLIP BAREFOOT A+B+C |
| LA-M LAPATTO MATE/MATT LAPPED | DCOF >0.50 |
| G GRANILLA PULIDA/GRAIN POLISHED | JR5MM JUNTA RECOMENDADA 5MM/RECOMMENDED JOINT 0,2" |
| E ESMALTE PULIDO/GLAZE POLISHED SHINY | T10MM ESPESOR 10MM/THICKNESS 0,4" |
| R RECTIFICADO/RECTIFIED | V1 ASPECTO UNIFORME/UNIFORM APPEARANCE |
| M-C MASA COLOREADA/COLORED BODY | V2 VARIACION LEVE/SLIGHT VARIATION |
| E-T ESPESORADO/THICKNESS | V3 VARIACION MODERADA/MODERATE VARIATION |
| M-M ENMALLADO/MESHED | V4 VARIACION FUERTE/SUBSTANTIAL VARIATION |
| M-M MODULARIDAD/MODULARITY | DD VARIACIÓN DE DISEÑO/GRAPHIC FACES: XX PIEZAS/PIECES |
| FP ANTIHIELO/FROST PROOF | RU4 USO RECOMENDADO/RECOMMENED USE - RU4 |
| | RU5 USO RECOMENDADO/RECOMMENED USE - RU5 |

reading the catalogue

lectura del catálogo

01

Nombre de la colección/
Collection name

02

Aplicación de la pieza/
Application of the piece

03

Descripción gráfica de la pieza/
Graphic description

04

Características de la pieza/
Piece characteristics

05

Nombre de la colección/
Collection name

06

Tipología de la colección/
Typology collection

07

Número de página/
Page number

Wabi Sabi

PELDAÑO RECTO

WABI

03

01 PELDAÑO RECTO ANT. C3 WABI BLANCO 33 x 100 / 13" x 40"	02 PELDAÑO RECTO ANT. C3 WABI GRANITE 33 x 100 / 13" x 40"	03 PELDAÑO RECTO ANT. C3 WABI SABBIA 33 x 100 / 13" x 40"	04 PELDAÑO RECTO ANT. C3 WABI TALPE 33 x 100 / 13" x 40"
---	--	---	--

05

ZANQUIN RECTO OCHA. (D2) WABI BLANCO 75 x 60 / 3" x 24"	ZANQUIN RECTO OCHA. (D2) WABI GRANITE 75 x 60 / 3" x 24"	ZANQUIN RECTO OCHA. (D2) WABI SABBIA 75 x 60 / 3" x 24"	ZANQUIN RECTO OCHA. (D2) WABI TALPE 75 x 60 / 3" x 24"
--	---	--	---

06

REMATE PELDAÑO RECTO WABI BLANCO 3,2 x 33 / 1,3" x 13"	REMATE PELDAÑO RECTO WABI GRANITE 3,2 x 33 / 1,3" x 13"	REMATE PELDAÑO RECTO WABI SABBIA 3,2 x 33 / 1,3" x 13"	REMATE PELDAÑO RECTO WABI TALPE 3,2 x 33 / 1,3" x 13"
---	--	---	--

07

TABICA WABI BLANCO 15 x 100 / 6" x 40"	TABICA WABI GRANITE 15 x 100 / 6" x 40"	TABICA WABI SABBIA 15 x 100 / 6" x 40"	TABICA WABI TALPE 15 x 100 / 6" x 40"
---	--	---	--

04

CARACTERÍSTICAS TÉCNICAS - TECHNICAL CHARACTERISTICS

E EXTRUSIONADO/EXTRUDED KUNNER	B ANTI-SLIP R11
M MATE/MATT	DCOF >0.50
R RECTIFICADO/RECTIFIED	C CLASE 3-CLASS 3
V VARIACION LEVE/SLIGHT VARIATION	AB ANTI-SLIP BAREFOOT A+B-C

05

06 DORSO ENTERRADO EN COLA DE MEJUNDO
DOVE SET IN GROUT

07 JUNTA RECOMENDADA 5 MM
RECOMMENDED JOINT BETWEEN PIECES 5MM

Wabi Sabi Pools

PELDAÑO RECTO

TRAVERTINO

PELDAÑO RECTO

MADAGASCAR

05

01 PELDAÑO RECTO ANT. C3 TRAVERTINO SILVER 33 x 100 / 13" x 40"	02 PELDAÑO RECTO ANT. C3 TRAVERTINO BRESCIA 33 x 100 / 13" x 40"	03 PELDAÑO RECTO ANT. C3 MADAGASCAR NOCE 33 x 100 / 13" x 40"
---	--	---

06

ZANQUIN RECTO OCHA. (D2) TRAVERTINO SILVER POL. 75 x 60 / 3" x 24"	ZANQUIN RECTO OCHA. (D2) TRAVERTINO BRESCIA POL. 75 x 60 / 3" x 24"	ZANQUIN RECTO OCHA. (D2) MADAGASCAR NOCE 75 x 60 / 3" x 24"
---	--	--

07

REMATE PELDAÑO RECTO TRAVERTINO SILVER 3,2 x 33 / 1,3" x 13"	REMATE PELDAÑO RECTO TRAVERTINO BRESCIA 3,2 x 33 / 1,3" x 13"	REMATE PELDAÑO RECTO MADAGASCAR NOCE 3,2 x 33 / 1,3" x 13"
---	--	---

08

TABICA TRAVERTINO SILVER 15 x 100 / 6" x 40"	TABICA TRAVERTINO BRESCIA 15 x 100 / 6" x 40"	TABICA MADAGASCAR NOCE 15 x 100 / 6" x 40"
---	--	---

09

PELDAÑO FIORENTINO

TRAVERTINO

10

01 PELDAÑO FOR. ANT. C3 TRAVERTINO SILVER 33x100 / 13" x 40"	02 PELDAÑO FOR. ANT. C3 TRAVERTINO BRESCIA 33x100 / 13" x 40"
--	---

11

REMATE FORJADO/PELDO TRAVERTINO SILVER 3,2x33 / 1,3" x 13"	REMATE FORJADO/PELDO TRAVERTINO BRESCIA 3,2x33 / 1,3" x 13"
---	--

12

REMATE FORJADO/PELDO TRAVERTINO SILVER 3,2x33 / 1,3" x 13"	REMATE FORJADO/PELDO TRAVERTINO BRESCIA 3,2x33 / 1,3" x 13"
---	--



collections

colecciones

PRIVATE POOLS / PISCINA PRIVADAS

4.Stones

20

Alabama

28

Burlington

36

Cross

46

Deep Blue

52

Himalayas

56

Illinois

60

Koen

70

Oregón

76

Oxford

82

Pierre de Bali

94

Triana

100

Vita

104

Wabi Sabi

114

Work

136

4.Stones

**Original or copy?
Natural or digital?**

At APE we question these pairs of contrary concepts with a collection of four stones tiles that defy the limits of manufacturing. Reproductions full of authenticity and their own essence, 4.Stones is a new way of understanding design, where quality, naturalness and sustainability go hand in hand.

**¿Original o copia?
¿Natural o digital?**

En APE ponemos en duda esta dualidad de conceptos contrarios con una colección de cuatro piedras cerámicas que desafían los límites de la fabricación. Reproducciones llenas de autenticidad y sabor propio, 4.Stones es una nueva forma de entender el diseño, donde calidad, naturalidad y también sostenibilidad se dan la mano.



APE

4.Stones Pools

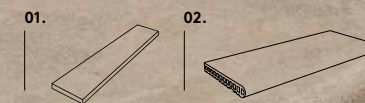

01. ANTI-SLIP BOURG RECT 60X120/24"X48" 02. BORDE PISCINA BOURG 28X66,5/11"X26"

4.Stones



01. ANTI-SLIP VALMALENCO RECT 60X120/24"X48"
 02. ANGULO PISCINA INT. VALMALENCO 33X33/13"X13"
 03. BORDE PISCINA VALMALENCO 28X66,5/11"X26"

PELDAÑO RECTO



C3 PELDAÑO RECTO ANT. C3 BOURG
 33 X 120 / 13" X 48" **K91/P**



C3 PELDAÑO RECTO ANT. C3 VALMALENCO
 33 X 120 / 13" X 48" **K91/P**



REMATE RECTO PELD. BOURG
 3.2 X 33 / 1.5" X 13" **K36/P**



REMATE RECTO PELD. VALMALENCO
 3.2 X 33 / 1.5" X 13" **K36/P**



ZANQUIN RECTO DCHA./IZQ. BOURG
 7,5 X 60 / 3" X 24" **K09/P**



ZANQUIN RECTO DCHA./IZQ. VALMALENCO
 7,5 X 60 / 3" X 24" **K09/P**



TABICA BOURG
 15 X 120 / 6" X 48" **K11/P**



TABICA VALMALENCO
 15 X 120 / 6" X 48" **K11/P**



ROD. BOURG / ROD. BOURG LAP
 7,5x60/3"X24" **K24/P**



ROD. VALMALENCO / ROD. VALMALENCO LAP
 7,5x60/3"X24" **K24/P**
 ROD. VALMALENCO
 7,5X90/ 3"X36" **K14/P**

TRADITIONAL POOL / PISCINA TRADICIONAL



REF. 232 UÑA BOURG
 4 X 4 / 1.5" X 1.5" **K06/P**



BORDE PISCINA BOURG
 28 X 66.5 / 11" X 26" **K94/P**



BORDE PISCINA VALMALENCO
 28 X 66.5 / 11" X 26" **K94/P**



REF. 222 MEDIA CAÑA BOURG
 4 X 33 / 1.5" X 33" **K29/P**



ANGULO PISCINA INT. BOURG
 33 X 33 / 13" X 13" **K39/P**



ANGULO PISCINA INT. VALMALENCO
 33 X 33 / 13" X 13" **K39/P**

CARACTERÍSTICAS TÉCNICAS - TECHNICAL CHARACTERISTICS

EXTRUSIONADO/EXTRUDED KLINKER RECTIFICADO/RECTIFIED **C3** CLASE 3/CLASS 3 **R11** ANTI-SLIP R11 ANTI-SLIP BAREFOOT A+B+C

4.Stones

BASES



M V2 RELIEVO BOURG RECT
60 X 120 / 24" X 48" P23/M



M V2 RELIEVO BOURG RECT
30 X 120 / 12" X 48" P24/M



M V2 RELIEVO BOURG RECT
20 X 120 / 8" X 48" P24/M



M C2 R10 V2 BOURG RECT
60 X 120 / 24" X 48" P20/M

*** V2** BOURG LAP RECT
60 X 120 / 24" X 48" P19/M

M C3 R11 V2 ANTI-SLIP BOURG RECT
60 X 120 / 24" X 48" P25/M

BASES



M C3 R11 V2 BOURG RECT
40 X 120 (2CM) / 16" X 48" P28/M*

*Espesor 20mm / thickness 0.8"



20mm
0.8"

ESPESORADO / HIGH THICKNESS



RELIEVO

LAPATTO

MATT

CARACTERÍSTICAS TÉCNICAS · TECHNICAL CHARACTERISTICS

- P** PORCELÁNICO/PORCELAIN TILES
- RECT** RECTIFICADO/RECTIFIED
- MC** MASA COLOREADA/COLORED BODY
- RF** ANTIHIELO/FROST PROOF
- RU5** USO RECOMENDADO/RECOMMENED USE - RU5
- ES** ESPESOR/THICKNESS
10MM -0,4"
40X120 - 20MM/0,79"

4.Stones

BASES



M C2 R10 V3 VALMALENCO RECT
60 X 120 / 24" X 48" P20/M

*** V3** VALMALENCO LAP RECT
60 X 120 / 24" X 48" P19/M

M C3 R11 V3 ANTI-SLIP VALMALENCO RECT
60 X 120 / 24" X 48" P25/M



M C2 R10 V3 VALMALENCO RECT
30 X 120 / 12" X 48" P22/M

*** V3** VALMALENCO LAP RECT
30 X 120 / 12" X 48" P21/M



M C2 R10 V3 VALMALENCO RECT
20 X 120 / 8" X 48" P22/M

*** V3** VALMALENCO LAP RECT
20 X 120 / 8" X 48" P21/M

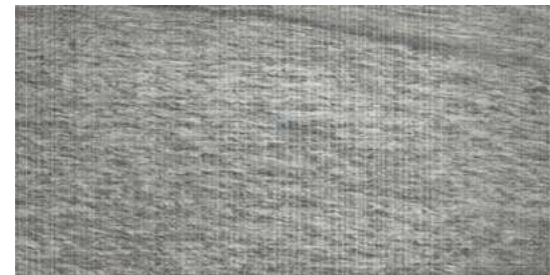

M V3 RELIEVO VALMALENCO RECT
60 X 120 / 24" X 48" P23/M



M V3 RELIEVO VALMALENCO RECT
30 X 120 / 12" X 48" P24/M



M V3 RELIEVO VALMALENCO RECT
20 X 120 / 8" X 48" P24/M

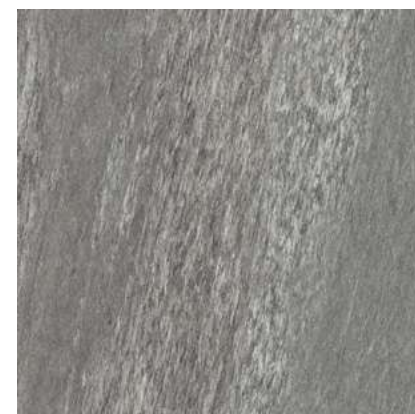

M C2 R10 V3 VALMALENCO RECT.
90 X 90 / 36" X 36" P10/M

CARACTERÍSTICAS TÉCNICAS · TECHNICAL CHARACTERISTICS

- P** PORCELÁNICO/PORCELAIN TILES
- RE** RECTIFICADO/RECTIFIED
- MC** MASA COLOREADA/COLORED BODY
- AF** ANTIHIELO/FROST PROOF
- RU5** USO RECOMENDADO/RECOMMENED USE - RU5
- E** ESPESOR/THICKNESS
10MM -0,4"
40X120 - 20MM/0,79"

BASES

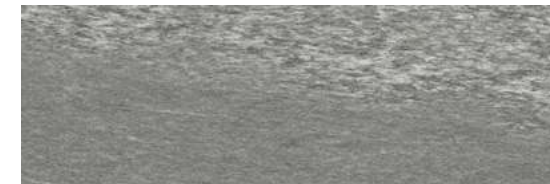

M C3 R11 V3 VALMALENCO RECT
40 X 120 (2CM) / 16" X 48" P28/M

*Espesor 20mm / thickness 0.8"



ESPEJORADO / HIGH THICKNESS



Alabama

A lifelong wood finish.

Un acabado en madera para toda la vida.

Alabama is a versatile collection of ceramic woods that works as the skin of the space. Its timeless beauty allows this series to match with different decorative styles. Alabama is designed to achieve global integration in all the spaces of the house: indoors, outdoors and swimming pool, covering the tank and the top throughout the traditional straight step system.

Alabama es una colección de maderas cerámicas versátil que funciona como piel del espacio. Su belleza atemporal la convierten en una serie que combina con diferentes estilos decorativos. Alabama está diseñada para lograr una integración global en todos los espacios de la vivienda: interior y exterior incluyendo la piscina, recubriendo el vaso y la coronación mediante el sistema tradicional con peldaño recto.



01. ANTI-SLIP ALABAMA QUERCIA RECT. 20X120/8"X48" 02. Peldaño recto ant. C3 ALABAMA QUERCIA 33X120X3 /13"X48"X1"

Alabama

APE

Alabama Pools

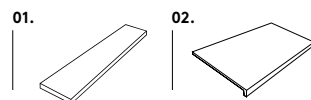

01. ANTI-SLIP ALABAMA QUERCIA RECT. 20X120/8"X48" 02. PELDAÑO RECTO ANT. C3 ALABAMA QUERCIA 33X120X3/13"X48"X1"

Alabama

APE

Alabama Pools



Traditional pools are efficient and its maintenance is simple. We have straight steps for them that will provide the swimming pool with a very contemporary touch.

Las piscinas tradicionales son eficientes y su mantenimiento es sencillo. Para ellas contamos con un peldaño recto que le dará un toque contemporáneo y muy actual a la piscina.

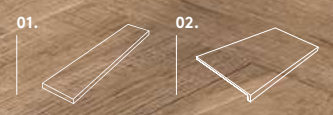
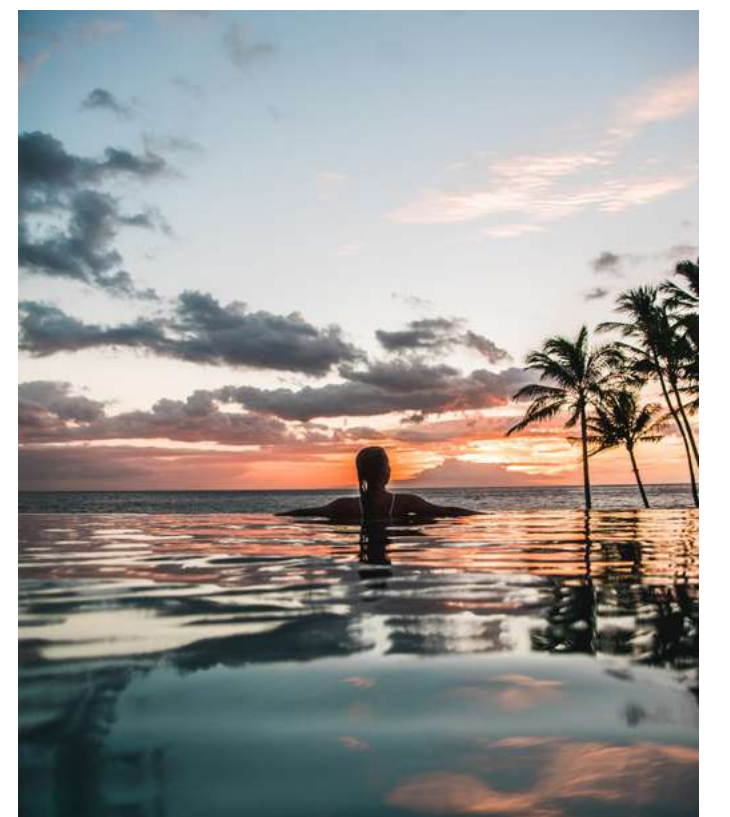

01. ANTI-SLIP ALABAMA SÁNDALO RECT. 20X120/8" X48" 02. PELDAÑO RECTO ANT. C3 ALABAMA SÁNDALO 33X120X3/13" X48" X1"

Alabama

PELDAÑO RECTO



C3 PELDAÑO RECTO ANT. C3 ALABAMA NEBBIA
33 X 120 / 13" X 48" **K91/P**



C3 PELDAÑO RECTO ANT. C3 ALABAMA CENERE
33 X 120 / 13" X 48" **K91/P**



C3 PELDAÑO RECTO ANT. C3 ALABAMA SÁNDALO
33 X 120 / 13" X 48" **K91/P**



REMATE RECTO PELD. ALABAMA NEBBIA
3.2 X 33 / 1.5" X 13" **K36/P**

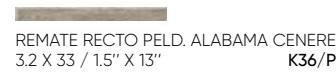

REMATE RECTO PELD. ALABAMA CENERE
3.2 X 33 / 1.5" X 13" **K36/P**

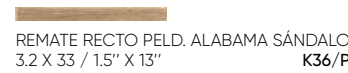

REMATE RECTO PELD. ALABAMA SÁNDALO
3.2 X 33 / 1.5" X 13" **K36/P**



TABICA ALABAMA NEBBIA
15 X 120 / 6" X 48" **K11/P**



TABICA ALABAMA CENERE
15 X 120 / 6" X 48" **K11/P**



TABICA ALABAMA SÁNDALO
15 X 120 / 6" X 48" **K11/P**

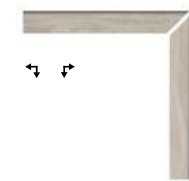

ZANQUIN RECTO DCHA./IZQ. ALABAMA NEBBIA
8 X 60 / 3" X 24" **K09/P**

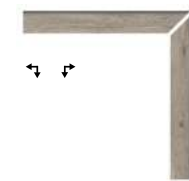

ZANQUIN RECTO DCHA./IZQ. ALABAMA CENERE
8 X 60 / 3" X 24" **K09/P**

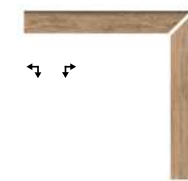

ZANQUIN RECTO DCHA./IZQ. ALABAMA SÁNDALO
8 X 60 / 3" X 24" **K09/P**



C3 PELDAÑO RECTO ANT. C3 ALABAMA QUERCIA
33 X 120 / 13" X 48" **K91/P**



REMATE RECTO PELD. ALABAMA QUERCIA
3.2 X 33 / 1.5" X 13" **K36/P**



TABICA ALABAMA QUERCIA
15 X 120 / 6" X 48" **K11/P**

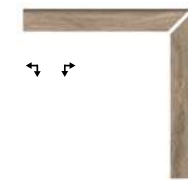

ZANQUIN RECTO DCHA./IZQ. ALABAMA QUERCIA
8 X 60 / 3" X 24" **K09/P**

CARACTERÍSTICAS TÉCNICAS · TECHNICAL CHARACTERISTICS

- P** EXTRUSIONADO/EXTRUDED KLINKER
- M** MATE/MATT
- V3** VARIACION MODERADA/MODERATE VARIATION
- R11** ANTI-SLIP R11
- C3** ANTI-SLIP BAREFOOT A+B+C
- C3** (DCOF) >0.50
- C3** CLASE 3/CLASS 3

 DORSO ESTRIADO EN COLA DE MILANO. DOVE TAIL PROFILE.

 JUNTA RECOMENDADA 5 MM. RECOMMENDED JOINT BETWEEN PIECES 5 MM.

BASES



C2 **R10** ALABAMA NEBBIA RECT
20 X 120 / 8" X 48" **R53/M**

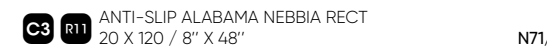

C3 **R11** ANTI-SLIP ALABAMA NEBBIA RECT
20 X 120 / 8" X 48" **N71/M**



C2 **R10** ALABAMA QUERCIA RECT
20 X 120 / 8" X 48" **R53/M**

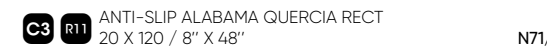

C3 **R11** ANTI-SLIP ALABAMA QUERCIA RECT
20 X 120 / 8" X 48" **N71/M**



C2 **R10** ALABAMA CENERE RECT
20 X 120 / 8" X 48" **R53/M**

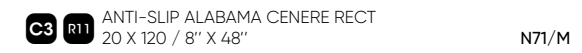

C3 **R11** ANTI-SLIP ALABAMA CENERE RECT
20 X 120 / 8" X 48" **N71/M**



C2 **R10** ALABAMA SANDALO RECT
20 X 120 / 8" X 48" **R53/M**

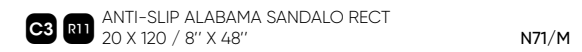

C3 **R11** ANTI-SLIP ALABAMA SANDALO RECT
20 X 120 / 8" X 48" **N71/M**



ROD. ALABAMA
8 X 60 / 3" X 24" **K24/P**

AVAILABLE IN ALL COLORS / DISPONIBLE EN TODOS LOS COLORES

CARACTERÍSTICAS TÉCNICAS · TECHNICAL CHARACTERISTICS

- P** PORCELÁNICO/PORCELAIN TILES
- M** MATE/MATT
- V3** VARIACION MODERADA/MODERATE VARIATION
- R10** ANTIHIELO/FROST PROOF
- R10** USO RECOMENDADO/RECOMMENDED USE - RU5
- R10** ESPESOR 10,5MM/THICKNESS 0,41"

Burlington

In this series we have worked on the graphic qualities that natural stone offers.

En esta serie hemos trabajado las cualidades gráficas que presenta la piedra natural

Deep in the mountains of Cumbria, UK, the purity of Lakeland water, volcanic ash, weathering and mineral processes have slowly formed Burlington. For centuries, this iconic stone, which has inspired our collection with the same name, has given life to beautiful interiors, naturally carved works and majestic spaces.

En las profundidades de las montañas de Cumbria (Reino Unido), la pureza del agua de Lakeland, la ceniza volcánica, la intemperie y los procesos minerales forman lentamente Burlington. Durante siglos, esta icónica piedra, que ha inspirado nuestra colección con el mismo nombre, ha dado vida a interiores hermosos, a trabajos tallados de forma natural y a majestuosos espacios.



01. ANTI-SLIP BURLINGTON GREY RECT. 60X120/24"X48" 02. Peldaño Recto Ant. C3 Burlington Grey 33X120/13"X48"
PIERRE DE BALI 15X15/6"X6" BURLINGTON GREY RECT. 60X120/24"X48"

Burlington

APE

Burlington Pools

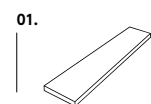

01. ANTI-SLIP BURLINGTON PEARL RECT. 60X120/24"X48"

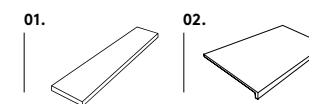

01. ANTI-SLIP BURLINGTON TAUPE RECT. 60X120/24"X48" 02. PELDAÑO RECTO ANT. C3 BURLINGTON TAUPE 33X120/13"X48"
CONTEMPORARY BLUESTONE 15X15/6"X6"

Burlington

APE

Burlington Pools

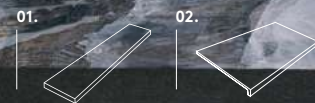

01. ANTI-SLIP BURLINGTON VOLCANO RECT. 75X75/30"X30" 02. PELDAÑO RECTO ANT. C3 BURLINGTON VOLCANO 33X120/13"X48"
BURLINGTON VOLCANO RECT. 60X120/24"X48" ANTI-SLIP MADAGASCAR NOCE RECT. 20X120/8"X48" DEEP BLUE OXID 15X15/6"X6"



Burlington

BASES



C2 R10 BURLINGTON PEARL RECT.
75 X 75 / 30" X 30" J57/M

C3 R11 ANTI-SLIP BURLINGTON PEARL RECT.
75 X 75 / 30" X 30" J58/M



C2 R10 BURLINGTON PEARL RECT.
60 X 120 / 24" X 48" J55/M

C3 R11 ANTI-SLIP BURLINGTON PEARL RECT.
60 X 120 / 24" X 48" J56/M



C2 R10 BURLINGTON PEARL RECT.
60 X 60 / 24" X 24" J59/M



C2 R10 BURLINGTON PEARL RECT.
30 X 60 / 12" X 24" J59/M



C2 R10 BURLINGTON GREY RECT.
75 X 75 / 30" X 30" J57/M

C3 R11 ANTI-SLIP BURLINGTON GREY RECT.
75 X 75 / 30" X 30" J58/M

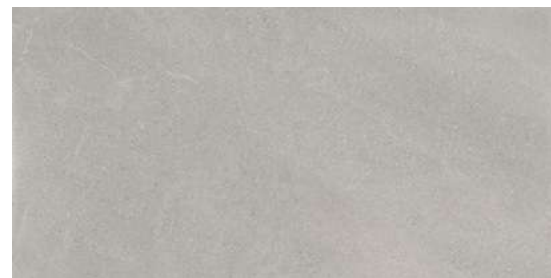

C2 R10 BURLINGTON GREY RECT.
60 X 120 / 24" X 48" J55/M

C3 R11 ANTI-SLIP BURLINGTON GREY RECT.
60 X 120 / 24" X 48" J56/M



C2 R10 BURLINGTON GREY RECT.
60 X 60 / 24" X 24" J59/M

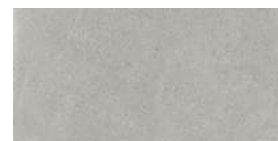

C2 R10 BURLINGTON GREY RECT.
30 X 60 / 12" X 24" J59/M



C2 R10 BURLINGTON VOLCANO RECT.
75 X 75 / 30" X 30" J57/M

C3 R11 ANTI-SLIP BURLINGTON VOLCANO RECT.
75 X 75 / 30" X 30" J58/M



C2 R10 BURLINGTON VOLCANO RECT.
60 X 120 / 24" X 48" J55/M

C3 R11 ANTI-SLIP BURLINGTON VOLCANO RECT.
60 X 120 / 24" X 48" J56/M



C2 R10 BURLINGTON VOLCANO RECT.
60 X 60 / 24" X 24" J59/M



C2 R10 BURLINGTON VOLCANO RECT.
30 X 60 / 12" X 24" J59/M

BASES



C2 R10 BURLINGTON IVORY RECT.
75 X 75 / 30" X 30" J57/M

C3 R11 ANTI-SLIP BURLINGTON IVORY RECT.
75 X 75 / 30" X 30" J58/M



C2 R10 BURLINGTON IVORY RECT.
60 X 120 / 24" X 48" J55/M

C3 R11 ANTI-SLIP BURLINGTON IVORY RECT.
60 X 120 / 24" X 48" J56/M

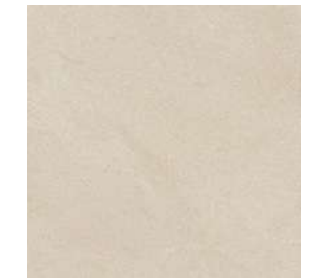

C2 R10 BURLINGTON IVORY RECT.
60 X 60 / 24" X 24" J59/M

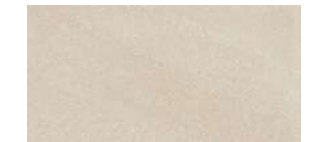

C2 R10 BURLINGTON IVORY RECT.
30 X 60 / 12" X 24" J59/M



C2 R10 BURLINGTON TAUPE RECT.
75 X 75 / 30" X 30" J57/M

C3 R11 ANTI-SLIP BURLINGTON TAUPE RECT.
75 X 75 / 30" X 30" J58/M



C2 R10 BURLINGTON TAUPE RECT.
60 X 120 / 24" X 48" J55/M

C3 R11 ANTI-SLIP BURLINGTON TAUPE RECT.
60 X 120 / 24" X 48" J56/M



C2 R10 BURLINGTON TAUPE RECT.
60 X 60 / 24" X 24" J59/M

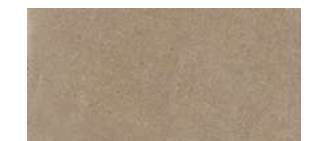

C2 R10 BURLINGTON TAUPE RECT.
30 X 60 / 12" X 24" J59/M

CARACTERÍSTICAS TÉCNICAS · TECHNICAL CHARACTERISTICS

P PORCELÁNICO/PORCELAIN TILES

M MATE/MATT

RE RECTIFICADO/RECTIFIED

V2 VARIACION LEVE / SLIGHT VARIATION

MC MASA COLOREADA/ COLORED BODY

RU5 USO RECOMENDADO/ RECOMMENED USE - RU5

AF ANTIHIELO/ FROST PROOF

T ESPESOR 11MM/ THICKNESS 0,43"

V VARIACIÓN DE DISEÑO/ GRAPHIC FACES:
75X75- 12 PIEZAS/PIECES
60X120- 12 PIEZAS/PIECES
60X60-24 PIEZAS/PIECES
30X60-48 PIEZAS/PIECES

Burlington

APE

Burlington Pools

PELDAÑO RECTO



C3 PELDAÑO RECTO ANT. C3 BURLINGTON PEARL
33 X 120 / 13" X 48" K91/P



C3 PELDAÑO RECTO ANT. C3 BURLINGTON GREY
33 X 120 / 13" X 48" K91/P



C3 PELDAÑO RECTO ANT. C3 BURLINGTON VOLCANO
33 X 120 / 13" X 48" K91/P

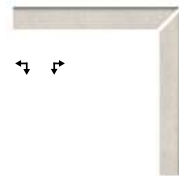

ZANQUIN RECTO DCHA./IZQ. BURLINGTON PEARL
7,5 X 60/ 3" X 24" K09/P

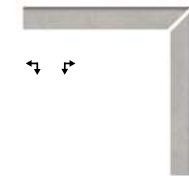

ZANQUIN RECTO DCHA./IZQ. BURLINGTON GREY
7,5 X 60/ 3" X 24" K09/P

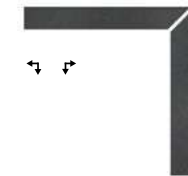

ZANQUIN RECTO DCHA./IZQ. BURLINGTON VOLCANO
7,5 X 60/ 3" X 24" K09/P



C3 PELDAÑO RECTO ANT. C3 BURLINGTON IVORY
33 X 120 / 13" X 48" K91/P



C3 PELDAÑO RECTO ANT. C3 BURLINGTON TAUPE
33 X 120 / 13" X 48" K91/P

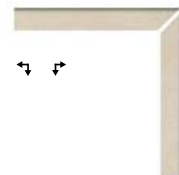

ZANQUIN RECTO DCHA./IZQ. BURLINGTON IVORY
7,5 X 60/ 3" X 24" K09/P

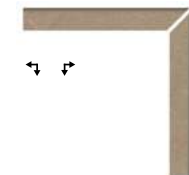

ZANQUIN RECTO DCHA./IZQ. BURLINGTON TAUPE
7,5 X 60/ 3" X 24" K09/P

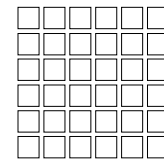

MOSAICO BURLINGTON
30X30(5X5)/ 12"X12" K01/P

AVAILABLE IN ALL COLORS / DISPONIBLE EN TODOS LOS COLORES



ROD. BURLINGTON 7,5 X 60 / 3" X 24" K24/P

ROD. BURLINGTON 7,5 X 75 / 3" X 30" K18/P

AVAILABLE IN ALL COLORS / DISPONIBLE EN TODOS LOS COLORES

CARACTERÍSTICAS TÉCNICAS · TECHNICAL CHARACTERISTICS



EXTRUSIONADO/EXTRUDED KLINKER



ANTI-SLIP R11



MATE/MATT



ANTI-SLIP BAREFOOT A+B+C



RECTIFICADO/RECTIFIED



(DCOF) >0.50



VARIACION LEVE/SLIGHT VARIATION



CLASE 3/CLASS 3



DORSO ESTRIADO EN COLA DE MILANO.
DOVE TAIL PROFILE.



JUNTA RECOMENDADA 5 MM.
RECOMMENDED JOINT BETWEEN PIECES 5 MM.



01.

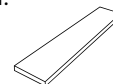

02.

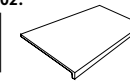

01. ANTI-SLIP BURLINGTON TAUPE RECT. 75X75/30"X30" 02. PELDAÑO RECTO ANT. C3 BURLINGTON IVORY 33X120/13"X48"
BURLINGTON IVORY RECT. 60X120/24"X48" DEEP BLUE OXID 15X15/6"X6"

Cross

Composed of a color palette with earth gray as the protagonist.

This product is a cross of natural elements that conceptually want to convey the sense of elegance, difference and exceptionality. We are talking about a fusion between a classic Burgundy Stone with the natural movement of an Onyx marble. Burgundy stone is a limestone from the historic region of central-eastern France, famous for its namesake Burgundy wines. It is an area that is crossed by a network of canals and dotted with large castles, and it is most likely one of the most beautiful regions not only in France but in all of Europe.

Los colores neutros y pétreos que provienen de la naturaleza.

Este producto es un cruce de elementos naturales que conceptualmente quieren transmitir el sentido de la elegancia, diferencia y excepcionalidad. Estamos hablando de una fusión entre una clásica Piedra de Borgoña junto a el movimiento natural de un mármol Ónice. La piedra de Borgoña es una limestone procedente de la región histórica de Francia centro-oriental, famosa por sus homónimos vinos de Borgoña. Es una zona que está atravesada por una red de canales y salpicada de grandes castillos, y es muy probablemente es una de las regiones más bellas no sólo de Francia sino de toda Europa.

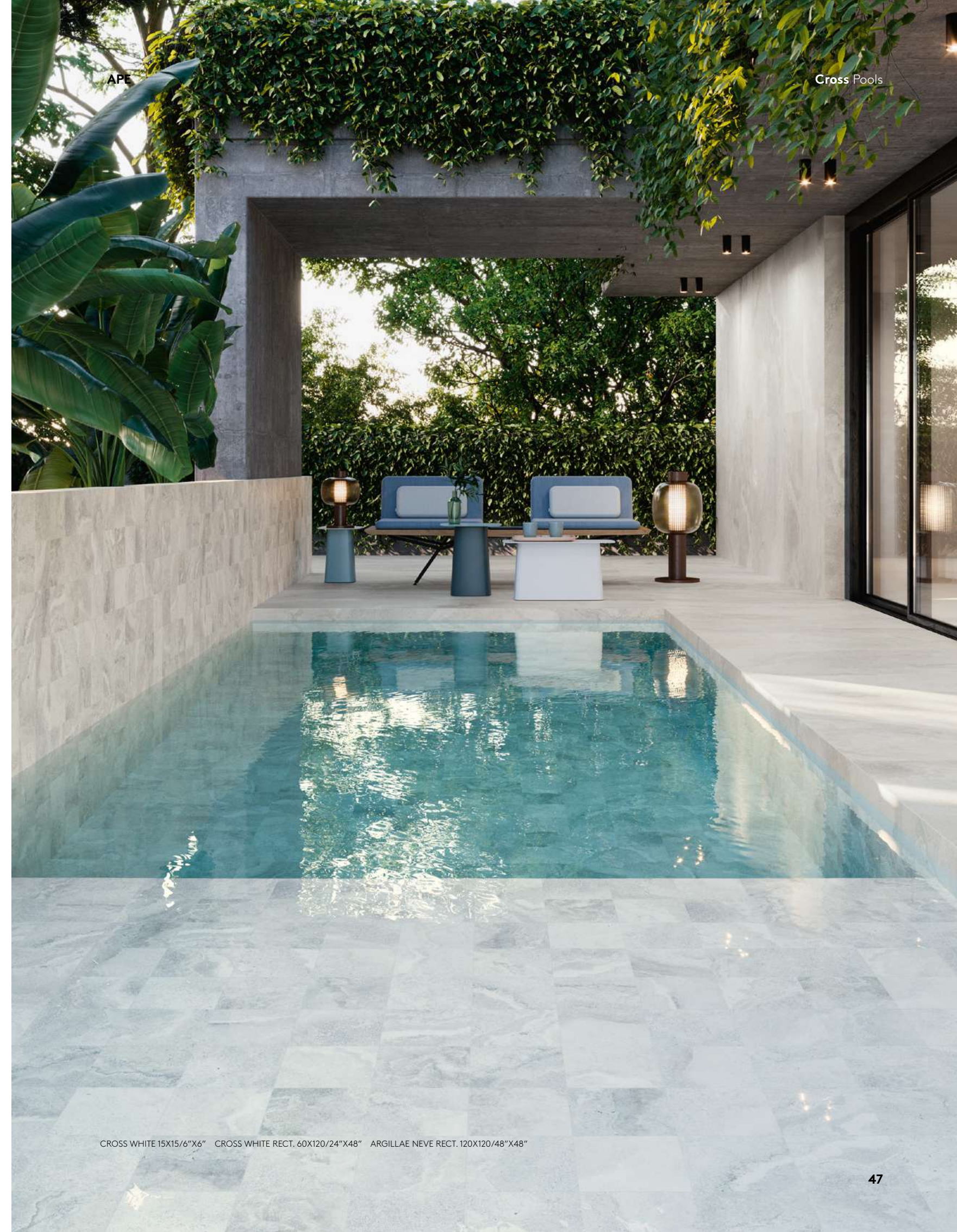

Cross

APE

Cross Pools



01.



01. PELDAÑO RECTO CROSS TAUPE C3 33X33/13"X13"
CROSS TAUPE 15X15/6"X6" CROSS TAUPE RECT. 60X120/24"X48"

Cross

PELDAÑO RECTO



PELDAÑO RECTO CROSS WHITE C3
33 X 33 / 13" X 13" K86/P









PELDAÑO RECTO CROSS SAND C3
33 X 33 / 13" X 13" K86/P



PELDAÑO RECTO CROSS TAUPE C3
33 X 33 / 13" X 13" K86/P

CARACTERÍSTICAS TÉCNICAS · TECHNICAL CHARACTERISTICS

-  EXTRUSIONADO/EXTRUDED KLINKER
-  MATE/MATT
-  VARIACION MODERADA/MODERATE VARIATION
-  ANTI-SLIP R11
-  ANTI-SLIP BAREFOOT A+B+C
-  (DCOF) >0.50
-  CLASE 3/CLASS 3

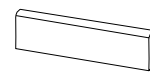

ROD. CROSS 7,5 X 60 / 3" X 24" K24/P

AVAILABLE IN ALL COLORS / DISPONIBLE EN TODOS LOS COLORES

 DORSO ESTRIADO EN COLA DE MILANO. DOVE TAIL PROFILE.
 JUNTA RECOMENDADA 5 MM. RECOMMENDED JOINT BETWEEN PIECES 5 MM.

BASES



 CROSS WHITE
15 X 15 / 6" X 6" L29/M



 CROSS SAND
15 X 15 / 6" X 6" L29/M



 CROSS TAUPE
15 X 15 / 6" X 6" L29/M



 MOSAICO CROSS WHITE
30 X 30 (5 X 5) / 12" X 12" K01/P



 MOSAICO CROSS SAND
30 X 30 (5 X 5) / 12" X 12" K01/P



 MOSAICO CROSS TAUPE
30 X 30 (5 X 5) / 12" X 12" K01/P



MALLA SPACCO CROSS WHITE
30 X 30 / 12" X 12" K70/P



MALLA SPACCO CROSS SAND
30 X 30 / 12" X 12" K70/P





MALLA SPACCO CROSS TAUPE
30 X 30 / 12" X 12" K70/P

BASES





 CROSS WHITE RECT
60 X 120 / 24" X 48" R60/M

   ANTI-SLIP CROSS WHITE RECT
60 X 120 / 24" X 48" N74/M





 CROSS SAND RECT
60 X 120 / 24" X 48" R60/M

   ANTI-SLIP CROSS SAND RECT
60 X 120 / 24" X 48" N74/M



 CROSS TAUPE RECT
60 X 120 / 24" X 48" R60/M

   ANTI-SLIP CROSS TAUPE RECT
60 X 120 / 24" X 48" N74/M



 CROSS WHITE RECT.
60 X 60 / 24" X 24" P07/M



 CROSS SAND RECT.
60 X 60 / 24" X 24" P07/M



 CROSS TAUPE RECT.
60 X 60 / 24" X 24" P07/M



 CROSS WHITE RECT.
30 X 60 / 12" X 24" P07/M





 CROSS SAND RECT.
30 X 60 / 12" X 24" P07/M



 CROSS TAUPE RECT.
30 X 60 / 12" X 24" P07/M

CARACTERÍSTICAS TÉCNICAS · TECHNICAL CHARACTERISTICS

-  PORCELÁNICO/PORCELAIN TILES
-  MATE/MATT
-  VARIACION MODERADA/MODERATE VARIATION
-  ESPESOR 10MM/THICKNESS 0,4"
-  VARIACIÓN DE DISEÑO/GRAPHIC FACES:
60X120- 12 PIEZAS/PIECES
60X60- 24 PIEZAS/PIECES
30X60- 48 PIEZAS/PIECES
15X15- 52 PIEZAS/PIECES

Deep Blue

Deep Blue is a natural stone known as 'Explosion blue', with an incredible charisma.

Deep Blue es una piedra natural conocida como 'Explosion blue', con un increíble carisma.

The sea water reveals before our eyes an extraordinary variety of blues, ranging from dark blue - the classic sea blue - to the turquoise of idyllic white sand beaches. The iconic images of the depths of the sea, coral reefs and Posidonia meadows of the Mediterranean have inspired Deep Blue, a collection by APE Grupo created as a decorative and design element for swimming pools.

El agua del mar despliega ante nuestros ojos una variedad de azules extraordinaria, que va desde el azul oscuro -el clásico azul marino- hasta el turquesa de las playas paradisíacas de arena blanca. Las icónicas imágenes de las profundidades del mar, de los arrecifes de corales y las praderas de posidonia han inspirado Deep Blue, una colección de APE Grupo pensada para exteriores y piscinas.

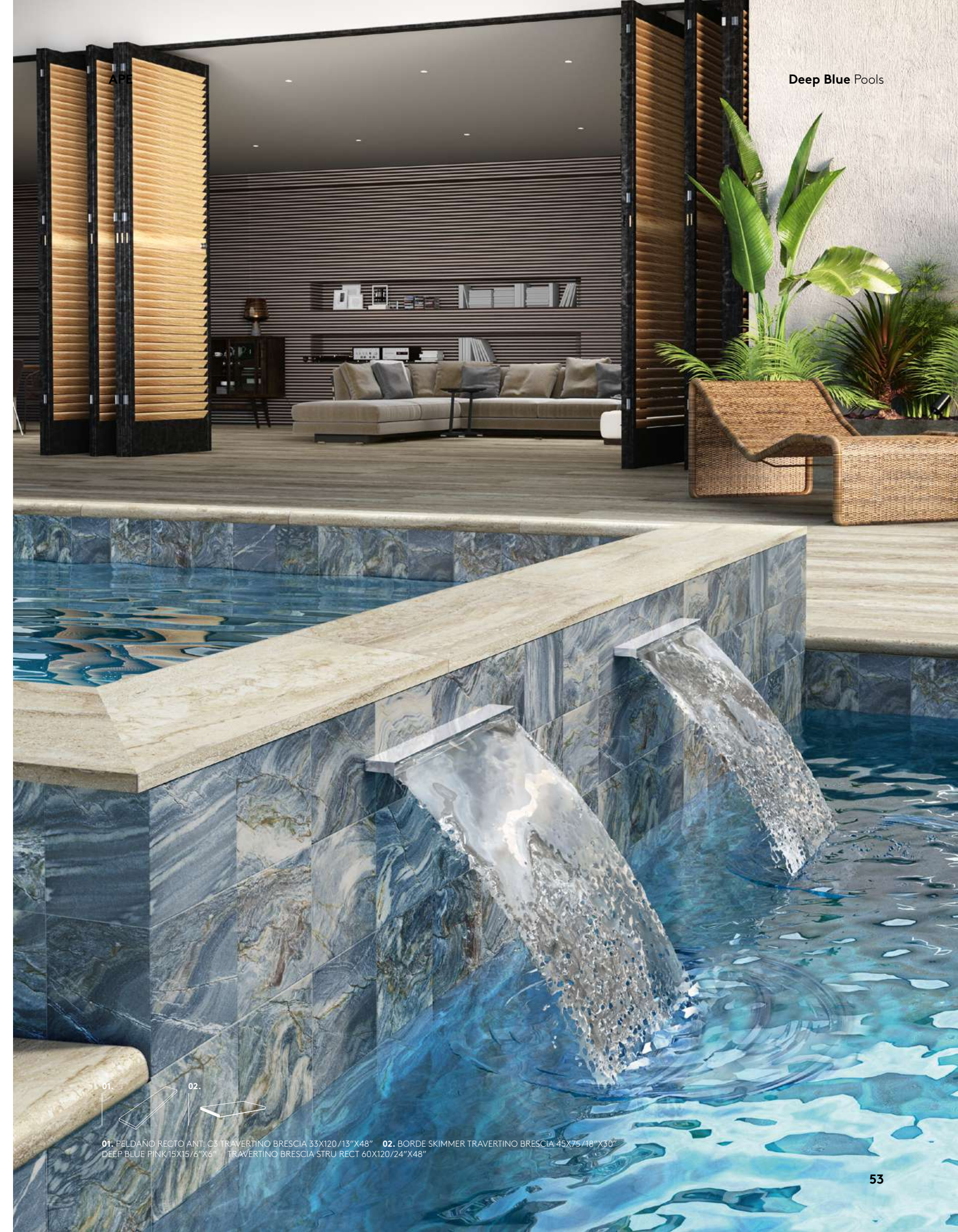

01. FIELDAÑO RECTO ANTI-C3 TRAVERTINO BRESCIA 33X120/13"X48" 02. BORDE SKIMMER TRAVERTINO BRESCIA 45X75/18"X30"
DEEP BLUE PINK 15X15/6"X6" TRAVERTINO BRESCIA STRU RECT 60X120/24"X48"

Deep Blue

BASES



C3 R11 DEEP BLUE OXID
30 X 60 / 12" X 24" J98/M

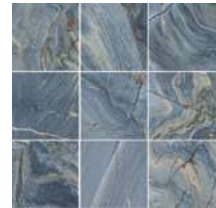

C2 R10 DEEP BLUE OXID
15 X 15 / 6" X 6" R59/M



C2 R10 DEEP BLUE PINK
15 X 15 / 6" X 6" R59/M



CARACTERÍSTICAS TÉCNICAS · TECHNICAL CHARACTERISTICS

- P** PORCELÁNICO / PORCELAIN TILES
- M** MATE / MATT
- V4** VARIACION FUERTE / SUBSTANTIAL VARIATION
- ANT** ANTIHIELO / FROST PROOF
- RU5** USO RECOMENDADO / RECOMMENED USE - RU5

- T** ESPESOR 9MM / THICKNESS 0,35"
- V** VARIACIÓN DE DISEÑO / GRAPHIC FACES
30X60 - 42 PIEZAS / PIECES
15X15 - 50 PIEZAS / PIECES

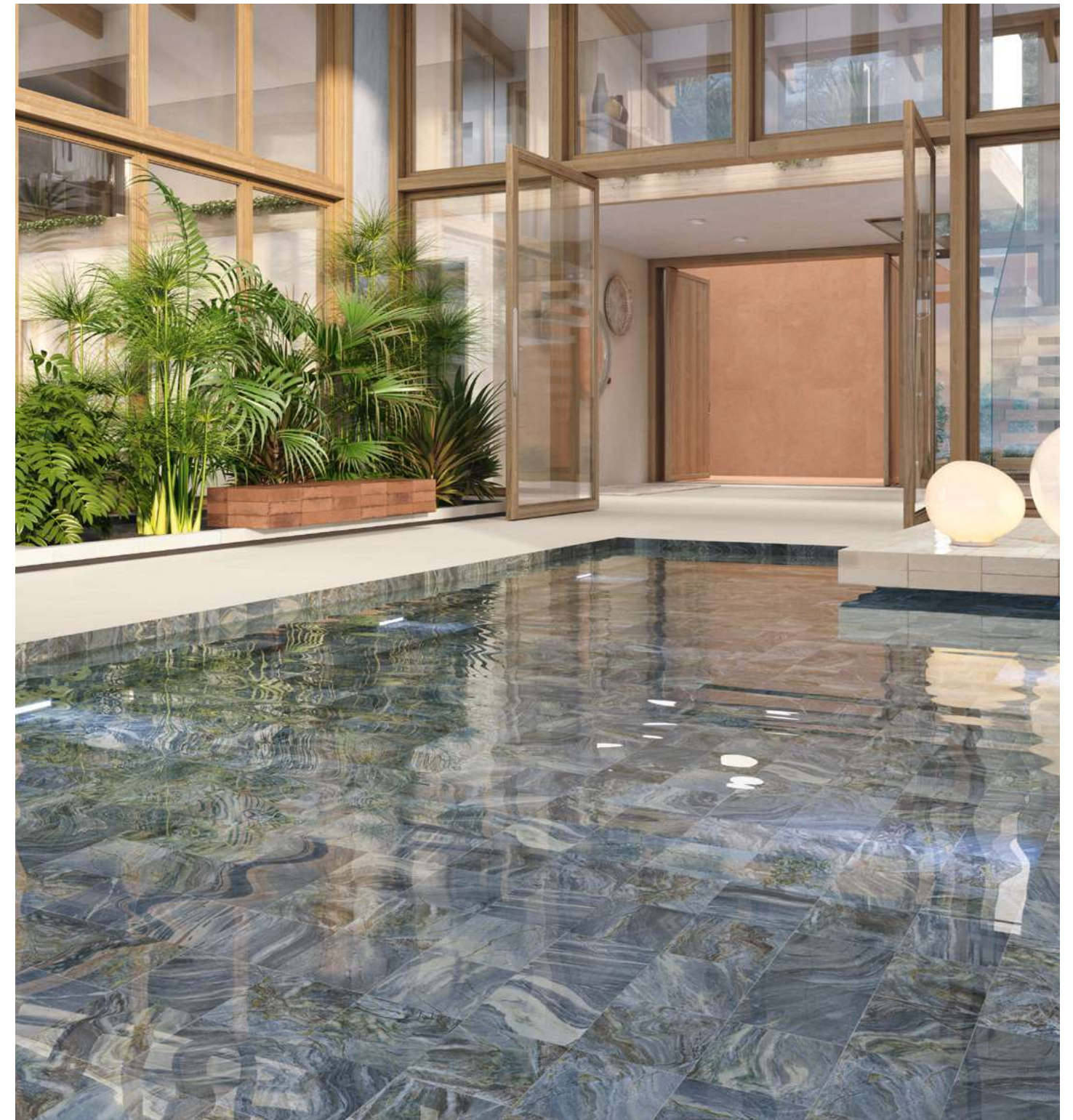

DEEP BLUE PINK 15X15/6"X6" ARGILLAE NEVE RECT. 120X120/48"X48" ARGILLAE GOBI RECT. 120X120/48"X48" MURUS TERRA 7X28/3"X11" MURUS NIX 7X28/3"X11"

Himalayas

A tribute to the iridescence of one of the most fascinating minerals in the world.

This collection, especially designed for swimming pools, reproduces the unmistakable materiality of labradorite. Its iridescence is unique and is characterized by green and bluish tones of unusual intensity. In its natural state it appears in the form of crystals that when polished reveal their incredible appearance. Thanks to digital decoration technologies on porcelain, we preserve its essence and make it suitable for spaces as demanding as a swimming pool.

Un homenaje a la iridiscencia de uno de los minerales más fascinantes del mundo.

Esta colección, especialmente pensada para piscinas, reproduce la inconfundible materialidad de la labradorita. Su iridiscencia es única y se caracteriza por unas tonalidades verdes y azuladas de una intensidad inusitada. En su estado natural aparece en forma de cristales que al pulirlos revelan su increíble aspecto. Gracias a las tecnologías de decoración digital sobre porcelánico, conservamos su esencia y la convertimos en apta para espacios tan exigentes como una piscina.



01.

01. Peldaño recto ant. C3 Burlington Ivory 33x120.
Himalayas Everest 15x15. ANTI-SLIP Burlington Ivory Rect. 60x120.

Himalayas

APE

Himalayas Pools

BASES



HIMALAYAS EVEREST
15X15 / 6"X6" L37/M



HIMALAYAS KATMANDU
15X15 / 6"X6" L37/M



HIMALAYAS NEPAL
15X15 / 6"X6" L37/M

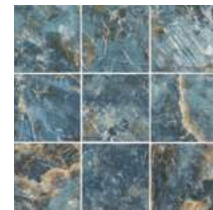

HIMALAYAS TIBET
15X15 / 6"X6" L37/M



HIMALAYAS NEPAL 15X15. ANTI-SLIP CROSS TAUPE RECT 60X120

CARACTERÍSTICAS TÉCNICAS · TECHNICAL CHARACTERISTICS

P PORCELÁNICO / PORCELAIN TILES

B BRILLO / SHINE

V3 VARIACION MODERADA / MODERATE VARIATION

RU4 USO RECOMENDADO / RECOMMENED USE - RU4

H ESPESOR 9MM / THICKNESS 0,35"

V VARIACIÓN DE DISEÑO / GRAPHIC FACES
15X15- 48 PIEZAS / PIECES

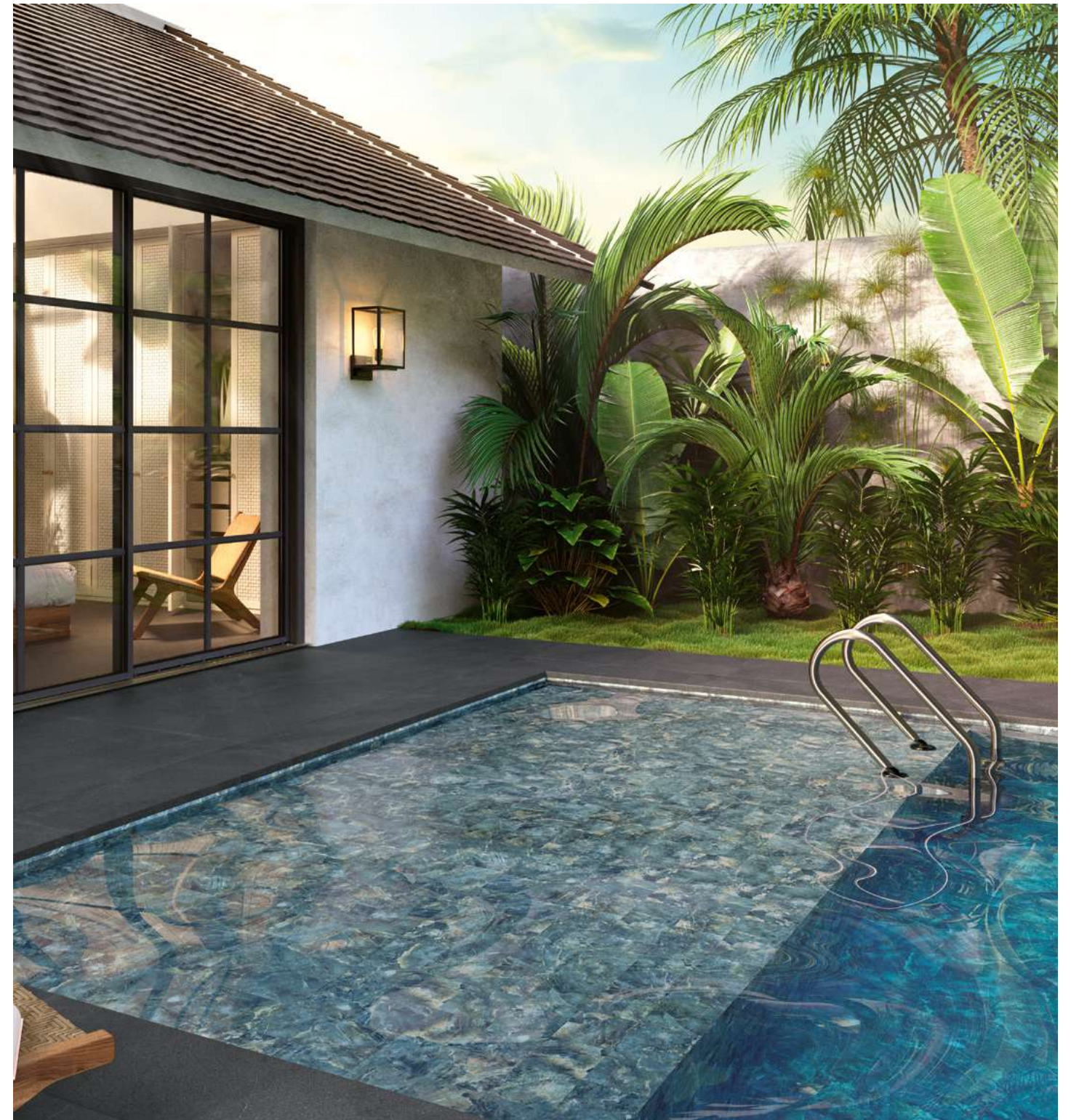

01.

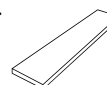

01. PELDAÑO RECTO ANT. C3 BURLINGTON VOLCANO 33X120.
HIMALAYAS TIBET 15X15. ANTI-SLIP BURLINGTON VOLCANO RECT. 60X120.

Illinois

Stunning and tremendously beautiful designs.

Diseños impactantes y tremendamente bellos.

In the past, cement was only used on the outside of buildings, but over the years, this rough material has conquered spaces and has seeped into the interior of the house giving meaning to the concept 'in-out'. We are, without a doubt, in front of a material, the ceramic cement, immune to the passage of time and with a decorative capacity without limits because it fits perfectly with other materials such as stone or wood.

En otras épocas, el cemento estaba relegado al exterior de las edificaciones, pero, con el paso de los años, este tosco material ha conquistado espacios y se ha colado en el interior de la vivienda para dar sentido al concepto 'in-out'. Estamos, sin duda, ante un material, el cemento cerámico, inmune al paso del tiempo y con una capacidad decorativa sin límites porque encaja a la perfección con otros materiales, como la piedra o la madera.

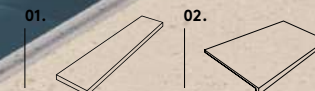

01. ANTI-SLIP ILLINOIS BONE RECT 60X120/24"X48" ILLINOIS BONE RECT 60X120/24"X48" 02. PELDAÑO RECTO ANT. C3 ILLINOIS BONE 33X120/13"X48" TRIANA CAOBA RECT 20X120/8"X48" CONTEMPORARY BLUESTONE 15X15/6"X6"

Illinois

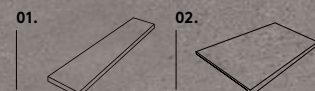

01. ANTI-SLIP ILLINOIS GRAPHITE RECT 60X120/24"X48" 02. PELDAÑO RECTO ANT. C3 ILLINOIS GRAPHITE 33X120/13"X48"
 ILLINOIS GRAPHITE RECT 100X100/40"X40" DELIGHT BLUE 13,8X13,8/5,5"X5,5"

Illinois

APE

Illinois Pools

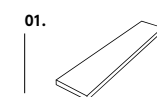

01. ANTI-SLIP ILLINOIS GREY RECT 60X120/24"X48"
DEEP BLUE OXID 15X15/6"X6"

Illinois

BASES

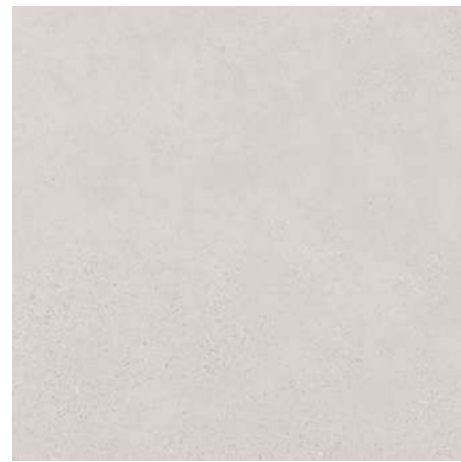

C3 R11 HIGH THICKNESS ILLINOIS WHITE
100 X 100 / 40" X 40" **L24/M**

C2 R10 ILLINOIS WHITE RECT
100 X 100 / 40" X 40" **N23/M**

C3 R12 ANTI-SLIP ILLINOIS WHITE RECT
100 X 100 / 40" X 40" **J97/M**



C3 R11 HIGH THICKNESS ILLINOIS GREY
100 X 100 / 40" X 40" **L24/M**

C2 R10 ILLINOIS GREY RECT
100 X 100 / 40" X 40" **N23/M**

C3 R12 ANTI-SLIP ILLINOIS GREY RECT
100 X 100 / 40" X 40" **J97/M**



C3 R11 HIGH THICKNESS ILLINOIS BONE
100 X 100 / 40" X 40" **L24/M**

C2 R10 ILLINOIS BONE RECT
100 X 100 / 40" X 40" **N23/M**

C3 R12 ANTI-SLIP ILLINOIS BONE RECT
100 X 100 / 40" X 40" **J97/M**



C3 R11 HIGH THICKNESS ILLINOIS GRAPHITE
100 X 100 / 40" X 40" **L24/M**

C2 R10 ILLINOIS GRAPHITE RECT
100 X 100 / 40" X 40" **N23/M**

C3 R12 ANTI-SLIP ILLINOIS GRAPHITE RECT
100 X 100 / 40" X 40" **J97/M**

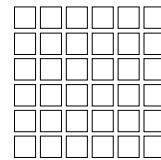

MALLA ILLINOIS
30X30(5X5)/ 12"X12" **K01/P**

AVAILABLE IN ALL COLORS
DISPONIBLE EN TODOS LOS COLORES

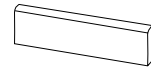

ROD. ILLINOIS
7.5 X 100 / 3" X 40" **K17/P**

ROD. ILLINOIS
7.5 X 75 / 3" X 30" **K18/P**

ROD. ILLINOIS
7.5 X 60 / 3" X 24" **K24/P**

AVAILABLE IN ALL COLORS /
DISPONIBLE EN TODOS LOS COLORES

*Espesor 20mm / thickness 0.8"

CARACTERÍSTICAS TÉCNICAS · TECHNICAL CHARACTERISTICS

P PORCELÁNICO /PORCELAIN TILES

M MATE /MATT

RECTIFICADO /RECTIFIED

V2 VARIACION LEVE /SLIGHT VARIATION

MASA COLOREADA /COLORED BODY

ANTHIELO /FROST PROOF

RU5 USO RECOMENDADO /RECOMMENED USE - RU5

ESPOSOR 10MM /THICKNESS 0,4"

VARIACIÓN DE DISEÑO /
GRAPHIC FACES
100X100- 9 PIEZAS/PIECES
75X75- 16 PIEZAS/PIECES
60X120- 15 PIEZAS/PIECES
60X60- 30 PIEZAS/PIECES

APE

BASES

Illinois Pools



C2 R10 ILLINOIS WHITE RECT
60 X 120 / 24" X 48" **J65/M**

C3 R12 ANTI-SLIP ILLINOIS WHITE RECT
60 X 120 / 24" X 48" **J66/M**



C2 R10 ILLINOIS GREY RECT
60 X 120 / 24" X 48" **J65/M**

C3 R12 ANTI-SLIP ILLINOIS GREY RECT
60 X 120 / 24" X 48" **J66/M**



C2 R10 ILLINOIS GRAPHITE RECT
60 X 120 / 24" X 48" **J65/M**

C3 R12 ANTI-SLIP ILLINOIS GRAPHITE RECT
60 X 120 / 24" X 48" **J66/M**



C2 R10 ILLINOIS BONE RECT
60 X 120 / 24" X 48" **J65/M**

C3 R12 ANTI-SLIP ILLINOIS BONE RECT
60 X 120 / 24" X 48" **J66/M**



C2 R10 ILLINOIS WHITE RECT.
60 X 60 / 24" X 24" **P17/M**



C2 R10 ILLINOIS GREY RECT.
60 X 60 / 24" X 24" **P17/M**



C2 R10 ILLINOIS GRAPHITE RECT.
60 X 60 / 24" X 24" **P17/M**



C2 R10 ILLINOIS BONE RECT.
60 X 60 / 24" X 24" **P17/M**



C2 R10 ILLINOIS WHITE RECT
75 X 75 / 30" X 30" **J63/M**

C3 R12 ANTI-SLIP ILLINOIS WHITE RECT
75 X 75 / 30" X 30" **J64/M**



C2 R10 ILLINOIS GREY RECT
75 X 75 / 30" X 30" **J63/M**

C3 R12 ANTI-SLIP ILLINOIS GREY RECT
75 X 75 / 30" X 30" **J64/M**



C2 R10 ILLINOIS GRAPHITE RECT
75 X 75 / 30" X 30" **J63/M**

C3 R12 ANTI-SLIP ILLINOIS GRAPHITE RECT
75 X 75 / 30" X 30" **J64/M**



C2 R10 ILLINOIS BONE RECT
75 X 75 / 30" X 30" **J63/M**

C3 R12 ANTI-SLIP ILLINOIS BONE RECT
75 X 75 / 30" X 30" **J64/M**

Illinois

APE

Illinois Pools

PELDAÑO RECTO



C3 PELDAÑO RECTO ANT. C3 ILLINOIS WHITE
33 X 120 / 13" X 48" **K91/P**



TABICA ILLINOISWHITE
15X120 / 6"X48" **K11/P**

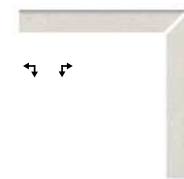

ZANQUIN RECTO DCHA./IZQ. ILLINOIS WHITE
7,5 X 60 / 3" X 24" **K09/P**



C3 PELDAÑO RECTO ANT. C3 ILLINOIS GREY
33 X 120 / 13" X 48" **K91/P**



TABICA ILLINOIS GREY
15X120 / 6"X48" **K11/P**

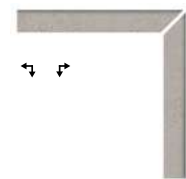

ZANQUIN RECTO DCHA./IZQ. ILLINOIS GREY
7,5 X 60 / 3" X 24" **K09/P**



C3 PELDAÑO RECTO ANT. C3 ILLINOIS GRAPHITE
33 X 120 / 13" X 48" **K91/P**



TABICA ILLINOIS GRAPHITE
15X120 / 6"X48" **K11/P**

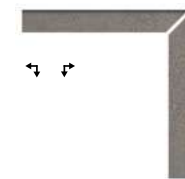

ZANQUIN RECTO DCHA./IZQ. ILLINOIS GRAPHITE
7,5 X 60 / 3" X 24" **K09/P**



C3 PELDAÑO RECTO ANT. C3 ILLINOIS BONE
33 X 120 / 13" X 48" **K91/P**



TABICA ILLINOIS BONE
15X120 / 6"X48" **K11/P**

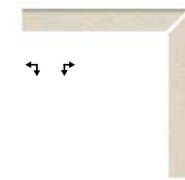

ZANQUIN RECTO DCHA./IZQ. ILLINOIS BONE
7,5 X 60 / 3" X 24" **K09/P**

CARACTERÍSTICAS TÉCNICAS · TECHNICAL CHARACTERISTICS



EXTRUSIONADO/EXTRUDED KLINKER



MATE/MATT



RECTIFICADO/RECTIFIED



VARIACION LEVE/SLIGHT VARIATION



ANTI-SLIP R11



ANTI-SLIP BAREFOOT A+B+C



(DCOF) >0.50



CLASE 3/CLASS 3



DORSO ESTRIADO EN COLA DE MILANO.
DOVE TAIL PROFILE.



JUNTA RECOMENDADA 5 MM.
RECOMMENDED JOINT BETWEEN PIECES 5 MM.

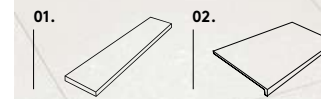

01. ANTI-SLIP ILLINOIS WHITE RECT 60X120/24"X48" 02. PELDAÑO RECTO ANT. C3 ILLINOIS WHITE 33X120/13"X48"
DEEP BLUE PINK 15X15/6"X6"

Koen

Japanese minimalism and Nordic warmth.

Minimalismo japonés y calidez nórdica.

Koen is a proposal for a vast ceramic wood collection capable of solving any challenge of interior design. It is available in multiple formats, and also comes in anti-slip and polished versions and with special pieces such as steps and endings. Therefore, this collection suits any kind of space well. Moreover, we have created decorative pieces inspired in Japan that reproduce the handcrafted work of wood. Koen impresses with its natural result that allows us to enjoy the warmth of wood in any moment and place.

Koen es una apuesta por una colección de madera cerámica amplia que sea capaz de resolver cualquier reto de interiorismo. Cuenta con multitud de formatos, pero también con versiones antislip, pulidas y piezas especiales como peldaños y remates, por lo que es una colección para cualquier tipo de espacio. Además, hemos creado unas piezas decorativas de inspiración nipona que reproduce el trabajo artesano de la madera. Koen impacta por su resultado natural que permite disfrutar de la calidez de la madera en cualquier momento y lugar.

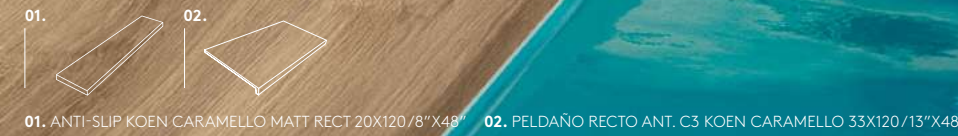

Koen

APE

Koen Pools

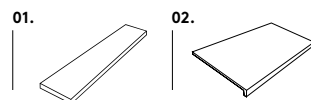

01. ANTI-SLIP KOEN MIELE MATT RECT 20X120/8"X48" 02. PELDAÑO RECTO ANT. C3 KOEN MIELE 33X120/13"X48"

Koen

PELDAÑO RECTO



C3 PELDAÑO RECTO ANT. C3 KOEN CAMELLO
33 X 120 / 13" X 48" **K91/P**



C3 PELDAÑO RECTO ANT. C3 KOEN MIELE
33 X 120 / 13" X 48" **K91/P**



C3 PELDAÑO RECTO ANT. C3 KOEN CENERE
33 X 120 / 13" X 48" **K91/P**



REMATE RECTO PELD. KOEN CAMELLO
3.2 X 33 / 1.5" X 13" **K36/P**



REMATE RECTO PELD. KOEN MIELE
3.2 X 33 / 1.5" X 13" **K36/P**



REMATE RECTO PELD. KOEN CENERE
3.2 X 33 / 1.5" X 13" **K36/P**



TABICA KOEN CAMELLO
15 X 120 / 6" X 48" **K11/P**



TABICA KOEN MIELE
15 X 120 / 6" X 48" **K11/P**



TABICA KOEN CENERE
15 X 120 / 6" X 48" **K11/P**

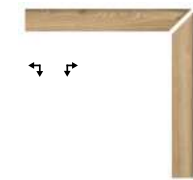

ZANQUIN RECTO DCHA./IZQ. KOEN CAMELLO MATT
8 X 60 / 3" X 24" **K09/P**

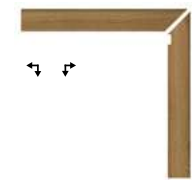

ZANQUIN RECTO DCHA./IZQ. KOEN MIELE MATT
8 X 60 / 3" X 24" **K09/P**

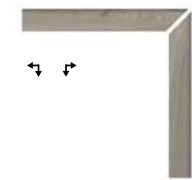

ZANQUIN RECTO DCHA./IZQ. KOEN CENERE MATT
8 X 60 / 3" X 24" **K09/P**

CARACTERÍSTICAS TÉCNICAS TECHNICAL CHARACTERISTICS

- EXTRUSIONADO/EXTRUDED KLINKER
- MATE/MATT
- RECTIFICADO/RECTIFIED
- VARIACION MODERADA/MODERATE VARIATION
- ANTI-SLIP R11
- ANTI-SLIP BAREFOOT A+B+C
- (DCOF) >0.50
- CLASE 3/CLASS 3



DORSO ESTRIADO EN COLA DE MILANO. JUNTA RECOMENDADA 5 MM.
DOVE TAIL PROFILE. RECOMMENDED JOINT BETWEEN PIECES 5 MM.



JUNTA RECOMENDADA 5 MM.
RECOMMENDED JOINT BETWEEN PIECES 5 MM.

BASES



C2 R10 KOEN CAMELLO MATT RECT
20 X 120 / 8" X 48" **R52/M**

C3 R11 ANTI-SLIP KOEN CAMELLO MATT RECT
20 X 120 / 8" X 48" **N72/M**



C2 R10 KOEN MIELE MATT RECT
20 X 120 / 8" X 48" **R52/M**

C3 R11 ANTI-SLIP KOEN MIELE MATT RECT
20 X 120 / 8" X 48" **N72/M**



C2 R10 KOEN CENERE MATT RECT
20 X 120 / 8" X 48" **R52/M**

C3 R11 ANTI-SLIP KOEN CENERE MATT RECT
20 X 120 / 8" X 48" **N72/M**



C2 R10 KOEN CAMELLO MATT RECT.
30 X 120 / 12" X 48" **R52/M**



C2 R10 KOEN MIELE MATT RECT.
30 X 120 / 12" X 48" **R52/M**

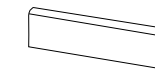

ROD. KOEN MATT
8 X 60 / 3" X 24" **K24/P**

AVAILABLE IN ALL COLORS / DISPONIBLE EN TODOS LOS COLORES

CARACTERÍSTICAS TÉCNICAS · TECHNICAL CHARACTERISTICS

- PORCELÁNICO/PORCELAIN TILES
- MATE/MATT
- RECTIFICADO/RECTIFIED
- VARIACION MODERADA/MODERATE VARIATION
- ANTIHIELO/FROST PROOF
- USO RECOMENDADO/RECOMMENDED USE - RU5
- ESPESOR/THICKNESS:
20X120 - 10MM/0,39"
30X120 - 10MM/0,39"

Oregón

Trendy woods with advanced material properties.

Maderas de tendencia con propiedades de materiales avanzados.

Oregón, an elegant wood that provides the different spaces of the house with warmth and naturalness. Thanks to its anti-slip edge, this collection allows us to enjoy pools with wooden finishes.

With Oregón, it is possible to take finishes such as beech, walnut, oak or wenge to spaces as demanding as a swimming pool without losing one bit of the technical properties of ceramics.

Oregón, una madera elegante que aporta calidez y naturalidad en los diferentes espacios de la vivienda. Gracias a su borde de acabado antideslizante, esta colección permite que podamos disfrutar de piscinas con acabados en madera.

Con Oregón es posible llevar acabados como el haya, el nogal, el roble o el wengué a espacios tan exigentes como una piscina sin perder un ápice de las propiedades técnicas de la cerámica.

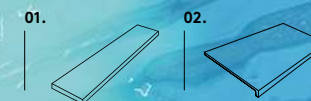

01. ANTI-SLIP OREGÓN NOGAL RECT. 20X120/8\"/>

Oregón

Oregón Pools



Visual and tactile wood finish and all the benefits of porcelain and extruded stoneware in resistance, maintenance and anti-slippage.

Acabado visual y táctil de la madera y todas las ventajas del gres porcelánico y extruido en resistencia, mantenimiento y antideslizamiento.

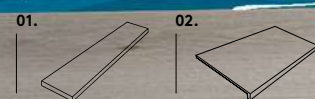
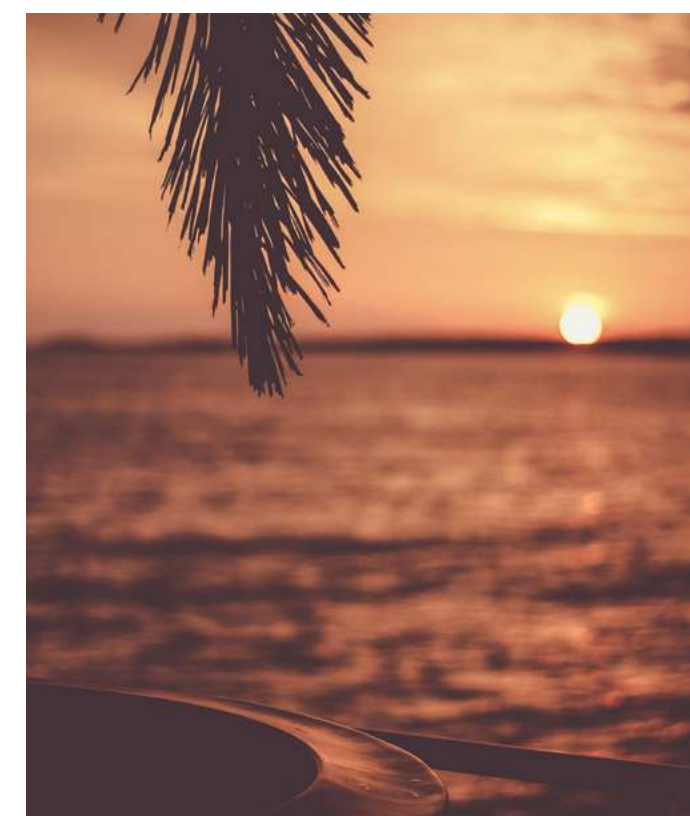

01. ANTI-SLIP OREGÓN GRIS RECT. 20X120/8\"X48\" 02. PELDAÑO RECTO ANT.C3 OREGON GRIS 33X120X3/13\"X48\"X1\"

Oregón

PELDAÑO RECTO



C3 PELDAÑO RECTO ANT. C3 OREGON GRIS
33 X 120 / 13" X 48" **K91/P**



REMATE RECTO PELDAÑO OREGON GRIS
3.2 X 33 / 1.5" X 13" **K36/P**



TABICA OREGON GRIS
15 X 120 / 6" X 48" **K11/P**

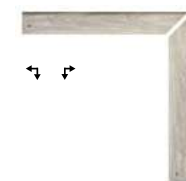

ZANQUIN RECTO DCHA. / IZQ. OREGON GRIS
8 X 60 / 3" X 24" **K09/P**



C3 PELDAÑO RECTO ANT. C3 OREGON NOGAL
33 X 120 / 13" X 48" **K91/P**



REMATE RECTO PELDAÑO OREGON NOGAL
3.2 X 33 / 1.5" X 13" **K36/P**



TABICA OREGON NOGAL
15 X 120 / 6" X 48" **K11/P**

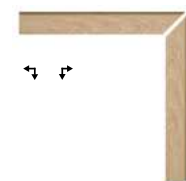

ZANQUIN RECTO DCHA. / IZQ. OREGON NOGAL
8 X 60 / 3" X 24" **K09/P**



C3 PELDAÑO RECTO ANT. C3 OREGON ROBLE
33 X 120 / 13" X 48" **K91/P**



REMATE RECTO PELDAÑO OREGON ROBLE
3.2 X 33 / 1.5" X 13" **K36/P**



TABICA OREGON ROBLE
15 X 120 / 6" X 48" **K11/P**

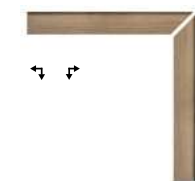

ZANQUIN RECTO DCHA. / IZQ. OREGON ROBLE
8 X 60 / 3" X 24" **K09/P**

CARACTERÍSTICAS TÉCNICAS · TECHNICAL CHARACTERISTICS

- E** EXTRUSIONADO/EXTRUDED KLINKER
- M** MATE/MATT
- V2** VARIACION LEVE/SLIGHT VARIATION
- R** RECTIFICADO/RECTIFIED
- R11** ANTI-SLIP R11
- (DCOF) >0.50**
- C3** CLASE 3/CLASS 3
- A+B+C** ANTI-SLIP BAREFOOT A+B+C



DORSO ESTRIADO EN COLA DE MILANO.
DOVE TAIL PROFILE.



JUNTA RECOMENDADA 5 MM.
RECOMMENDED JOINT BETWEEN PIECES 5 MM.

BASES



OREGON GRIS RECT
20 X 120 / 8" X 48" **R52/M**

C3 R11 ANTI-SLIP OREGON GRIS RECT
20 X 120 / 8" X 48" **N72/M**



OREGON NOGAL RECT
20 X 120 / 8" X 48" **R52/M**

C3 R11 ANTI-SLIP OREGON NOGAL RECT
20 X 120 / 8" X 48" **N72/M**



OREGON ROBLE RECT
20 X 120 / 8" X 48" **R52/M**

C3 R11 ANTI-SLIP OREGON ROBLE RECT
20 X 120 / 8" X 48" **N72/M**



ROD. OREGON
8 X 60 / 3" X 24" **K24/P**

AVAILABLE IN ALL COLORS / DISPONIBLE EN TODOS LOS COLORES

CARACTERÍSTICAS TÉCNICAS · TECHNICAL CHARACTERISTICS

- P** PORCELÁNICO/PORCELAIN TILES
- M** MATE/MATT
- R** RECTIFICADO/RECTIFIED
- V2** VARIACION LEVE/SLIGHT VARIATION
- +** ANTIHIELO/FROST PROOF
- RU5** USO RECOMENDADO/RECOMMENDED USE - RU5
- T** ESPESOR 10MM/THICKNESS 0,4"

Oxford

Oxford collection is inspired in concrete materials.

La colección Oxford se inspira en materiales cementosos.

This collection will allow you to feel the smooth touch of water on your skin. Be relaxed. Be comfortable.

Enjoy the swimming pool in the coziness of your home, close to what you love the most, your family, your belongings. A space constructed to integrate into any architecture by its nature. It is highly durable and resistant and has an anti-slip surface, and is softer and more durable thanks to the absence of exaggerated reliefs.

With Oxford ceramics, you will have a different pool, a unique space, your own paradise without giving up a single minute of your free time.

It is so functional and practical that it allows you to personalize the design, shape, colors and every detail. The different ceramic pieces adapt both to the swimming pool tank and its perimeter.

La colección Oxford se presenta para hacerte sentir el suave contacto del agua en tu piel. Estar relajado. Estar cómodo.

Disfrutar de la piscina en la comodidad de tu hogar, cerca de lo que más quieres, tu familia, tus cosas... Un espacio construido para integrarse en cualquier arquitectura por su carácter natural, de alta durabilidad, resistencia y con una superficie antideslizante suave y más duradera por la ausencia de relieves exagerados.

Con la cerámica Oxford tendrás una piscina diferente, un espacio único, tu propio paraíso particular, sin tener que renunciar ni siquiera a un minuto de tu tiempo libre.

Es tan funcional y práctica que permite personalizar el diseño, la forma, los colores y todos sus detalles. Las diferentes piezas cerámicas se adaptan tanto al vaso de la piscina como a la zona de playa.



Oxford

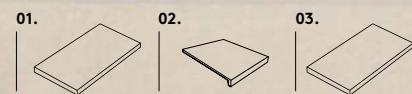

01. OXFORD C3 PURE 33X66,5/13"X26" 02. PELDAÑO RECTO OXFORD PURE C3 33X33 /13"X13" 03. OXFORD C1 PURE 33X66,5/13"X26"

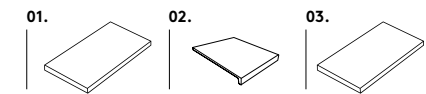
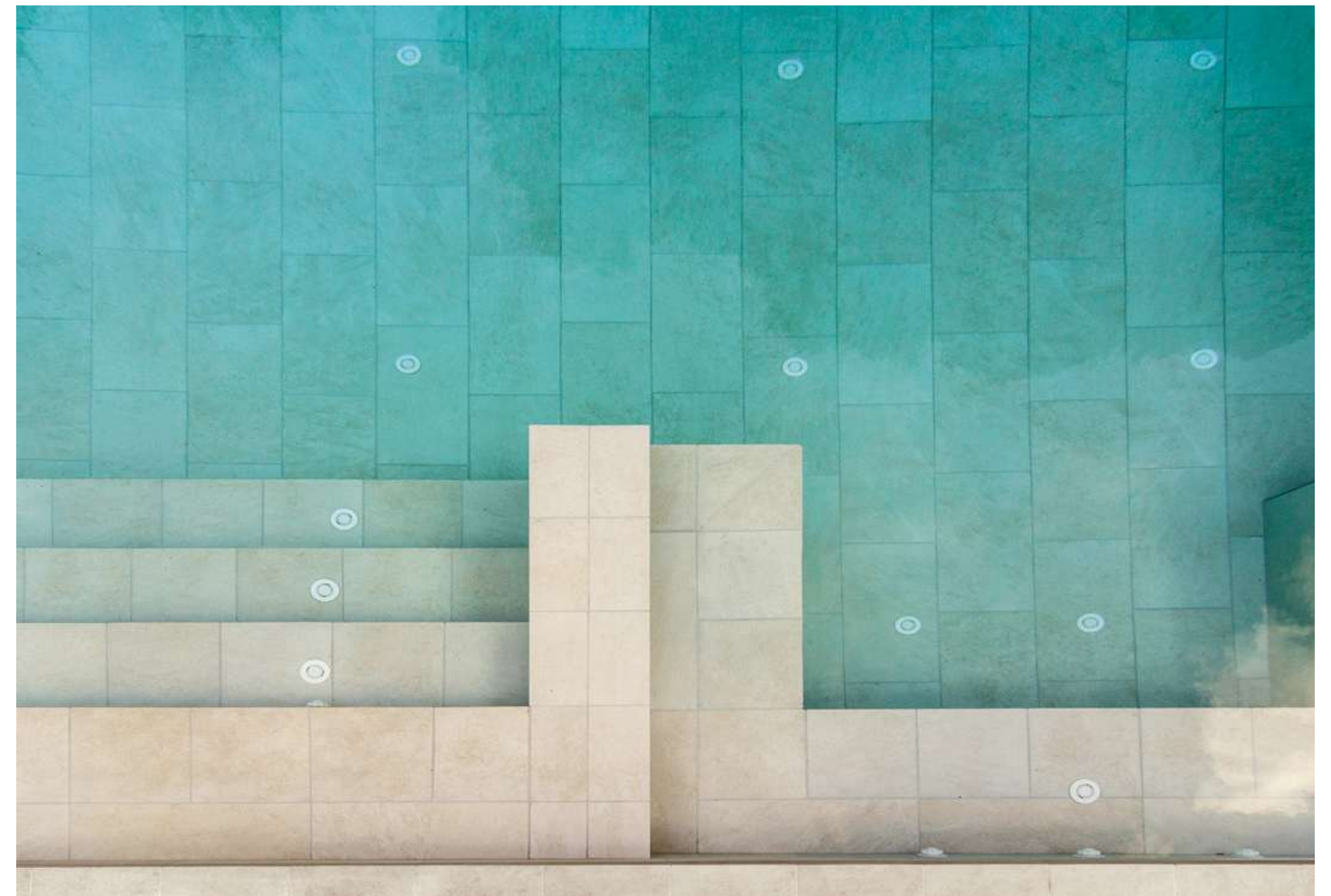

01. OXFORD C3 PURE 33X66,5/13"X26" 02. PELDAÑO RECTO OXFORD PURE C3 33X33/13"X13"
03. OXFORD C1 PURE 33X66,5/13"X26"

Oxford



01. OXFORD C3 PURE 33X66,5/13"X26" 02. BORDE DESBORDANTE OXFORD PURE 28X66,5/11"X26"
 03. REJILLA OXFORD PURE 24,5X24,5/9,4"X9,4" 04. PELDAÑO RECTO OXFORD PURE C3 33X33 /13"X13" 05. OXFORD C1 PURE 33X66,5/13"X26"

Oxford



Overflow pools are irresistible. Water is at the same level as the edge, creating a spectacular lake effect.

Las piscinas desbordantes son irresistibles. En ellas el agua está al mismo nivel que el borde, así se crea un espectacular efecto lago.

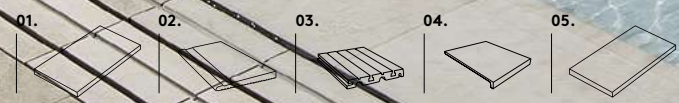

01. OXFORD C3 PURE 33X66,5/13"X26" 02. BORDE DESBORDANTE OXFORD PURE 28X66,5/11"X26"
 03. REJILLA OXFORD PURE 24,5X24,5/9,4"X9,4" 04. PELDANO RECTO OXFORD PURE C3 33X33/13"X13" 05. OXFORD C1 PURE 33X66,5/13"X26"

TRADITIONAL POOL / PISCINA TRADICIONAL



BORDE PISCINA OXFORD PURE
28 X 66.5 / 11" X 26" **K94/P**



BORDE PISCINA OXFORD ASHEN
28 X 66.5 / 11" X 26" **K94/P**



BORDE PISCINA OXFORD NEUTRAL
28 X 66.5 / 11" X 26" **K94/P**



BORDE PISCINA OXFORD SLATE
28 X 66.5 / 11" X 26" **K94/P**



ANGULO PISCINA EXT. OXFORD PURE
28 X 28 / 11" X 11" **K39/P**



ANGULO PISCINA EXT. OXFORD ASHEN
28 X 28 / 11" X 11" **K39/P**



ANGULO PISCINA EXT. OXFORD NEUTRAL
28 X 28 / 11" X 11" **K39/P**



ANGULO PISCINA EXT. OXFORD SLATE
28 X 28 / 11" X 11" **K39/P**



ANGULO PISCINA INT. OXFORD PURE
33 X 33 / 13" X 13" **K39/P**



ANGULO PISCINA INT. OXFORD ASHEN
33 X 33 / 13" X 13" **K39/P**



ANGULO PISCINA INT. OXFORD NEUTRAL
33 X 33 / 13" X 13" **K39/P**



ANGULO PISCINA INT. OXFORD SLATE
33 X 33 / 13" X 13" **K39/P**



REF. 222 MEDIA CAÑA OXFORD PURE
4 X 33 / 1.5" X 13" **K29/P**



REF. 222 MEDIA CAÑA OXFORD ASHEN
4 X 33 / 1.5" X 13" **K29/P**



REF. 222 MEDIA CAÑA OXFORD NEUTRAL
4 X 33 / 1.5" X 13" **K29/P**



REF. 222 MEDIA CAÑA OXFORD SLATE
4 X 33 / 1.5" X 13" **K29/P**



REF. 232 UÑA OXFORD PURE
4 X 4 / 1.5" X 1.5" **K06/P**



REF. 232 UÑA OXFORD ASHEN
4 X 4 / 1.5" X 1.5" **K06/P**



REF. 232 UÑA OXFORD NEUTRAL
4 X 4 / 1.5" X 1.5" **K06/P**



REF. 232 UÑA OXFORD SLATE
4 X 4 / 1.5" X 1.5" **K06/P**

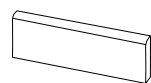

RODAPIE OXFORD
9 X 33 / 3.5" X 13" **K34/P**

AVAILABLE IN ALL COLORS / DISPONIBLE EN TODOS LOS COLORES

CARACTERÍSTICAS TÉCNICAS · TECHNICAL CHARACTERISTICS



EXTRUSIONADO/EXTRUDED KLINKER



MATE/MATT



VARIACION FUERTE/SUBSTANTIAL VARIATION



ANTI-SLIP R11



(DCOF) >0.50



CLASE 3 / CLASS 3



ANTI-SLIP BAREFOOT A+B+C



MEDIA CAÑA
4X33 / 1.5"X13"



DORSO ESTRIADO EN COLA DE MILANO.
DOVE TAIL PROFILE.



JUNTA RECOMENDADA 5 MM.
RECOMMENDED JOINT BETWEEN PIECES 5 MM.

OVERFLOW POOL / PISCINA DESBORDANTE



BORDE DESBORDANTE OXFORD PURE
28 X 66.5 / 11" X 26" **K94/P**



BORDE DESBORDANTE OXFORD ASHEN
28 X 66.5 / 11" X 26" **K94/P**



BORDE DESBORDANTE OXFORD NEUTRAL
28 X 66.5 / 11" X 26" **K94/P**



BORDE DESBORDANTE OXFORD SLATE
28 X 66.5 / 11" X 26" **K94/P**



REJILLA OXFORD PURE
24.5 X 24.5 / 9.4" X 9.4" **K57/P**



REJILLA OXFORD ASHEN
24.5 X 24.5 / 9.4" X 9.4" **K57/P**



REJILLA OXFORD NEUTRAL
24.5 X 24.5 / 9.4" X 9.4" **K57/P**



REJILLA OXFORD SLATE
24.5 X 24.5 / 9.4" X 9.4" **K57/P**

PELDAÑO RECTO



CARTABON RECTO OXFORD PURE
33 X 33 / 13" X 13" **K78/P**



CARTABON RECTO OXFORD ASHEN
33 X 33 / 13" X 13" **K78/P**



CARTABON RECTO OXFORD NEUTRAL
33 X 33 / 13" X 13" **K78/P**



CARTABON RECTO OXFORD SLATE
33 X 33 / 13" X 13" **K78/P**



PELDAÑO RECTO OXFORD C3 PURE
33 X 33 / 13" X 13" **K86/P**



PELDAÑO RECTO OXFORD C3 ASHEN
33 X 33 / 13" X 13" **K86/P**



PELDAÑO RECTO OXFORD C3 NEUTRAL
33 X 33 / 13" X 13" **K86/P**



PELDAÑO RECTO OXFORD C3 SLATE
33 X 33 / 13" X 13" **K86/P**



TABICA OXFORD PURE
15 X 33 / 6" X 13" **K11/P**



TABICA OXFORD ASHEN
15 X 33 / 6" X 13" **K11/P**



TABICA OXFORD NEUTRAL
15 X 33 / 6" X 13" **K11/P**



TABICA OXFORD SLATE
15 X 33 / 6" X 13" **K11/P**

Oxford

APE

Oxford Pools

BASES

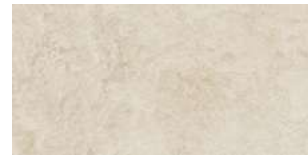

C3 R11 OXFORD PURE C3
33 X 66.5 / 13" X 26" L36/M

OXFORD PURE C1
33 X 66.5 / 13" X 26" R48/M



C3 R11 OXFORD ASHEN C3
33 X 66.5 / 13" X 26" L36/M

OXFORD ASHEN C1
33 X 66.5 / 13" X 26" R48/M



C3 R11 OXFORD NEUTRAL C3
33 X 66.5 / 13" X 26" L36/M

OXFORD NEUTRAL C1
33 X 66.5 / 13" X 26" R48/M



C3 R11 OXFORD SLATE C3
33 X 66.5 / 13" X 26" L36/M

OXFORD SLATE C1
33 X 66.5 / 13" X 26" R48/M



CARACTERÍSTICAS TÉCNICAS · TECHNICAL CHARACTERISTICS

- P** PORCELÁNICO/PORCELAIN TILES
- M** MATE/MATT
- V4** VARIACION FUERTE/SUBSTANTIAL VARIATION
- ANT** ANTIHIELO/FROST PROOF
- RU5** USO RECOMENDADO/RECOMMENED USE - RU5
- T** ESPESOR 10MM/THICKNESS 0,4"

C1 CLASE 1/CLASS 1 (DISPONIBLE EN TODOS LOS COLORES / AVAILABLE IN ALL COLORS)

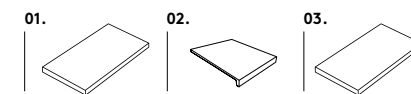

01. OXFORD C3 PURE 33X66,5/13"X26" 02. PELDAÑO RECTO OXFORD PURE C3 33X33/13"X13" 03. OXFORD C1 PURE 33X66,5/13"X26"

Pierre de Bali

Elegant and exotic.

Elegante y exótica.

Pierre de Bali recreates an original stone from this serene island in Southeast Asia and helps us feel at one with nature, giving any space in our home its own identity. Elegant and exotic, this collection has a specific series for outdoors and pools.

Pierre de Bali reproduce una piedra original de la isla del sudeste asiático que aporta serenidad y nos ayuda a integrarnos con la naturaleza, dotando a cualquier zona de nuestro hogar de identidad propia. Elegante y exótica, esta colección tiene una serie específica para exteriores y piscina.



01.

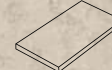

02.



01. PIERRE DE BALI 15X15/6"X6" 02. PELDAÑO RECTO PIERRE DE BALI C3 33X33/13"X13"

Pierre de Bali



Famous for its lush volcanic mountains, iconic rice paddies, stunning beaches and coral reefs, Bali is one of Indonesia's most popular islands.

Conocida por sus frondosas montañas volcánicas, además de por los icónicos arrozales, las playas y los arrecifes de coral, Bali da nombre a una de las islas más turísticas de Indonesia.



01. STBU-WABI SABBIA RECT 60X120/24"X48". 02. BORDE DESBORDANTE WABI SABBIA 28X66,5/11,1X26,2. 03. REJILLA WABI SABBIA 24,5X24,5/9,4"X9,4". PIERRE DE BALI 15X15/6"X6"

Pierre de Bali

APE

Pierre de Bali Pools



BASES

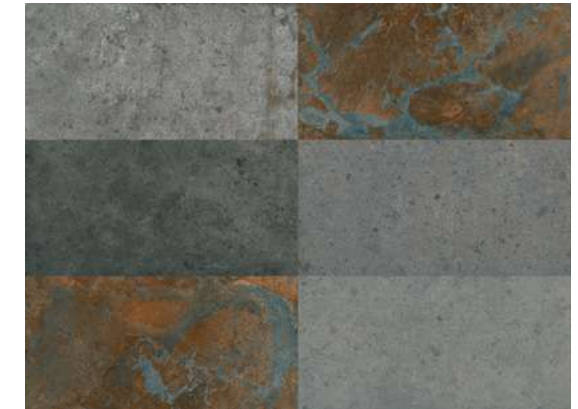

PIERRE DE BALI MIX
30 X 60 / 12" X 24" J27/M

C3 **R11** ANTI-SLIP PIERRE DE BALI MIX
30 X 60 / 12" X 24" N79/M



C2 PIERRE DE BALI
15 X 15 / 6" X 6" R59/M



ROD. PIERRE DE BALI MIX
7,5X60 / 3"X24" K24/P



PELDAÑO RECTO PIERRE DE BALI C3
33X33 / 13"X13" K86/P

- P** EXTRUSIONADO/EXTRUDED KLINKER
- C3** CLASE 3/CLASS 3
- R11** ANTI-SLIP BAREFOOT A+B+C

CARACTERÍSTICAS TÉCNICAS - TECHNICAL CHARACTERISTICS

- P** PORCELÁNICO/PORCELAIN TILES
- M** MATE/MATT
- V4** VARIACION FUERTE/SUBSTANTIAL VARIATION
- +** ANTIHIELO/FROST PROOF
- RU5** USO RECOMENDADO/RECOMMENED USE - RU5
- +** ESPESOR 8MM/THICKNESS 0,3"
- +** VARIACIÓN DE DISEÑO/GRAPHIC FACES
30X60 - 42 PIEZAS/42 PIECES
15X15 - 50 PIEZAS/50 PIECES

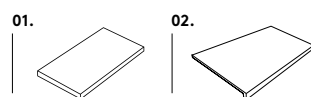

01. PIERRE DE BALI 15X15/6"X6" 02. PELDAÑO RECTO PIERRE DE BALI C3 33X33/13"X13"

Triana

The music can be felt in each of its lines. You can hear it; you can feel it.

La música se siente en cada una de sus líneas. Puedes escucharla; puedes sentirla.

Triana, in Seville, has traditionally been an area of sailors, workers, potters and manufacturers. It is also flamenco, music and art. The guitar and ceramics have shared prominence in the streets of this district.

The history of Triana has inspired a wood collection that takes into consideration every detail, such as the craftsmen who make Spanish guitars in the small workshops of Seville or the Flamenco artists who caress the strings of this instrument.

Triana, en Sevilla, ha sido tradicionalmente una zona de marineros, obreros, alfareros e industriales. También es flamenco, música y arte. La guitarra y la cerámica han compartido protagonismo en las calles de este barrio. La historia de Triana ha inspirado una colección de maderas que cuida con mimo cada detalle, como el de los artesanos que fabrican las guitarras españolas en pequeños talleres de Sevilla o el de los flamencos cuando acarician las cuerdas de este instrumento.

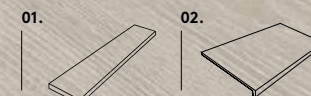
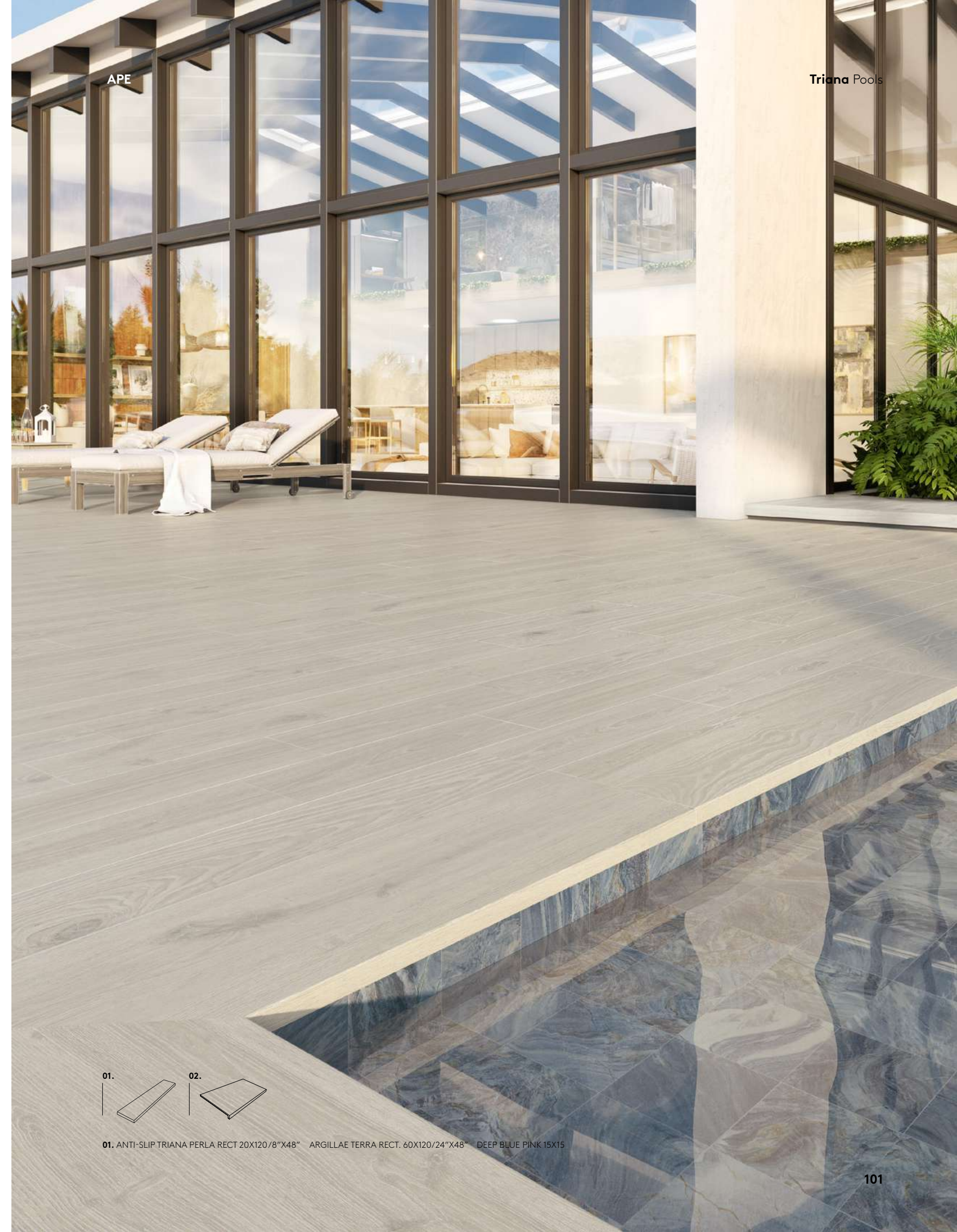

01. ANTI-SLIP TRIANA PERLA RECT 20X120/8"X48" ARGILLAE TERRA RECT. 60X120/24"X48" DEEP BLUE PINK 15X15

PELDAÑO RECTO

BASES



C3 PELDAÑO RECTO ANT. C3 TRIANA HAYA
33 X 120 / 13" X 48" K91/P

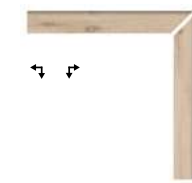

ZANQUIN RECTO DCHA./IZQ. TRIANA HAYA
10 X 60 / 4" X 24" K09/P



TABICA TRIANA HAYA
15 X 120 / 6" X 48" K11/P



C3 PELDAÑO RECTO ANT. C3 TRIANA DESIERTO
33 X 120 / 13" X 48" K91/P

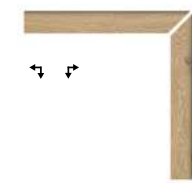

ZANQUIN RECTO DCHA./IZQ. TRIANA DESIERTO
10 X 60 / 4" X 24" K09/P



TABICA TRIANA DESIERTO
15 X 120 / 6" X 48" K11/P



C3 PELDAÑO RECTO ANT. C3 TRIANA CAOBA
33 X 120 / 13" X 48" K91/P

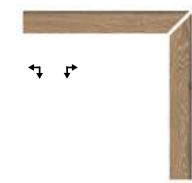

ZANQUIN RECTO DCHA./IZQ. TRIANA CAOBA
10 X 60 / 4" X 24" K09/P



TABICA TRIANA CAOBA
15 X 120 / 6" X 48" K11/P



C3 PELDAÑO RECTO ANT. C3 TRIANA PERLA
33 X 120 / 13" X 48" K91/P

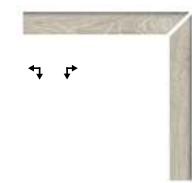

ZANQUIN RECTO DCHA./IZQ. TRIANA PERLA
10 X 60 / 4" X 24" K09/P



TABICA TRIANA PERLA
15 X 120 / 6" X 48" K11/P



TRIANA HAYA RECT
20 X 120 / 8" X 48" R52/M

C3 R11 ANTI-SLIP TRIANA HAYA RECT
20 X 120 / 8" X 48" N72/M



TRIANA DESIERTO RECT
20 X 120 / 8" X 48" R52/M

C3 R11 ANTI-SLIP TRIANA DESIERTO RECT
20 X 120 / 8" X 48" N72/M



TRIANA CAOBA RECT
20 X 120 / 8" X 48" R52/M

C3 R11 ANTI-SLIP TRIANA CAOBA RECT
20 X 120 / 8" X 48" N72/M



TRIANA PERLA RECT
20 X 120 / 8" X 48" R52/M

C3 R11 ANTI-SLIP TRIANA PERLA RECT
20 X 120 / 8" X 48" N72/M



TRIANA CENIZA RECT
20 X 120 / 8" X 48" R52/M



TRIANA CANELA RECT
20 X 120 / 8" X 48" R52/M



ROD. TRIANA
10 X 120 / 4" X 48" K02/P

AVAILABLE IN ALL COLORS / DISPONIBLE EN TODOS LOS COLORES

CARACTERÍSTICAS TÉCNICAS TECHNICAL CHARACTERISTICS

- E** EXTRUSIONADO/EXTRUDED KLINKER
- M** MATE/MATT
- R** RECTIFICADO/RECTIFIED
- V3** VARIACION MODERADA/MODERATE VARIATION
- R11** ANTI-SLIP R11
- A+B+C** ANTI-SLIP BAREFOOT A+B+C
- (DCOF) >0.50**
- C3** CLASE 3/CLASS 3

DORSO ESTRIADO EN COLA DE MILANO. JUNTA RECOMENDADA 5 MM.
DOVE TAIL PROFILE. RECOMMENDED JOINT BETWEEN PIECES 5 MM.

CARACTERÍSTICAS TÉCNICAS · TECHNICAL CHARACTERISTICS

- P** PORCELÁNICO/PORCELAIN TILES
- M** MATE/MATT
- R** RECTIFICADO/RECTIFIED
- V3** VARIACION MODERADA/MODERATE VARIATION
- +** ANTIHIELO/FROST PROOF
- RU5** USO RECOMENDADO/RECOMMENDED USE - RU5
- 10MM** ESPESOR 10MM/THICKNESS 0,4"
- 18** VARIACIÓN DE DISEÑO/GRAPHIC FACES: 18 PIEZAS/PIECES

Vita

Ceramic white marble design for exterior swimming pools.

Mármol blanco cerámico diseñado para piscinas exteriores.

The Vita series is inspired in white marble and appears to be the ideal option for the inside, the outside, and swimming pools. Given its finishes in Class 1 and Class 3, this series achieves an aesthetic continuity between the inside and the outside of the house, including the swimming pool, with suitable technical attributes and a unique design. Vita is the perfect solution for the traditional pools.

La serie Vita está inspirada en mármol blanco y se presenta como la opción ideal para interiores, exteriores y piscinas. Los acabados en Clase 1 y Clase 3 permiten que esta serie logre una continuidad estética entre el interior y el exterior de la vivienda, incluyendo la piscina, con características técnicas apropiadas y un diseño único. Vita es la solución perfecta para las piscinas tradicionales.

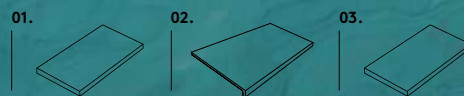

01. NUOVA STRU RECT. 60X120/24"X48" 02. PELDAÑO RECTO NUOVA 33X120X3/13"X48"X1" 03. LUCE MATT RECT. 60X120/24"X48"

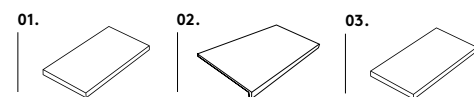

01. NUOVA STRU RECT. 60X120/24"X48" 02. PELDAÑO RECTO NUOVA 33X120X3/13"X48"X1" 03. LUCE MATT RECT. 60X120/24"X48"

Vita

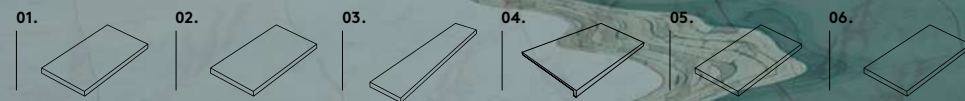

01. NUOVA STRU RECT. 60X120/24"X48" 02. NUOVA STRU RECT. 30X60/12"X24"
 03. ANTI-SLIP ALABAMA SÁNDALO RECT. 20X120/8"X48" 04. PELDAÑO RECTO ANT. C3 ALABAMA SÁNDALO 33X120X3/13"X48"X1" 05. LUCE MATT RECT. 60X120/24"X48" 06. LUCE MATT RECT. 30X60/12"X24"



01. NUOVA STRU RECT. 60X120/24"X48" 02. PELDAÑO RECTO NUOVA 33X120X3/13"X48"X1" 03. LUCE MATT RECT. 60X120/24"X48"

It improves the aesthetics of the whole space, both in interior and exterior projects, and the space surrounding the swimming pool is flaunted more intensely.

Mejora la estética de todo el espacio, tanto en proyectos de exterior como de interior, todo el espacio que rodea la piscina luce con más fuerza.



PELDAÑO RECTO



PELDAÑO RECTO NUOVA
33 X 120 / 13" X 48" **K91/P**



REMATE RECTO PELDAÑO NUOVA
3.2 X 33 / 1.5" X 13" **K36/P**

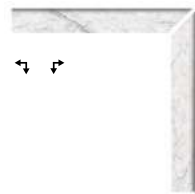

ZANQUIN RECTO DCHA./IZQ. NUOVA STRU
7,5X60/3"X24" **K09/P**



TABICA NUOVA
15 X 120 / 6" X 48" **K11/P**

BASES



M C3 R11 RU5 NUOVA STRU RECT
60 X 120 / 24" X 48" **N74/M**



M C3 R11 RU5 NUOVA STRU RECT.
60 X 60 / 24" X 24" **N33/M**



M C3 R11 RU5 NUOVA STRU RECT.
30 X 60 / 12" X 24" **N33/M**

BASES



M RU5 LUCE MATT RECT
120 X 120 / 48" X 48" **N31/M**

M C2 RU5 LUCE C2 RECT
120 X 120 / 48" X 48" **N34/M**

E RU4 VITA POLISHED RECT
120 X 120 / 48" X 48" **P06/M**



M RU5 LUCE MATT RECT
60 X 120 / 24" X 48" **R60/M**

M C2 RU5 LUCE C2 RECT
60 X 120 / 24" X 48" **N67/M**

E RU4 VITA POLISHED RECT
60 X 120 / 24" X 48" **J18/M**



M RU5 LUCE MATT RECT.
60 X 60 / 24" X 24" **P07/M**

M C2 RU5 LUCE C2 RECT.
60 X 60 / 24" X 24" **N18/M**

E RU4 VITA POLISHED RECT.
60 X 60 / 24" X 24" **N29/M**



M RU5 LUCE MATT RECT.
30 X 60 / 12" X 24" **P07/M**

M C2 RU5 LUCE C2 RECT.
30 X 60 / 12" X 24" **N18/M**

E RU4 VITA POLISHED RECT.
30 X 60 / 12" X 24" **N29/M**

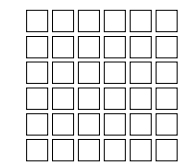

MALLA LUCE MATT
30X30 (5X5) /12" X 12" **K01/P**

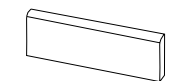

RODAPIE LUCE MATT
7.5 X 60 / 3" X 24" **K24/P**



DORSO ESTRIADO EN COLA DE MILANO.
DOVE TAIL PROFILE.



JUNTA RECOMENDADA 5 MM.
RECOMMENDED JOINT BETWEEN PIECES 5 MM.

CARACTERÍSTICAS TÉCNICAS - TECHNICAL CHARACTERISTICS



EXTRUSIONADO/EXTRUDED KLINKER



MATE/MATT



VARIACION LEVE/SLIGHT VARIATION



ANTI-SLIP R11



(DCOF) >0.50



CLASE 3 / CLASS 3



ANTI-SLIP BAREFOOT A+B+C

CARACTERÍSTICAS TÉCNICAS - TECHNICAL CHARACTERISTICS



PORCELÁNICO/PORCELAIN TILES



RECTIFICADO/RECTIFIED



VARIACIÓN DE DISEÑO/GRAPHIC FACES
120X120 - 8 PIEZAS/PIECES
60X120 - 16 PIEZAS/PIECES
60X60 - 32 PIEZAS/PIECES
30X60 - 64 PIEZAS/PIECES



VARIACION LEVE/SLIGHT VARIATION



ANTIHIELO/FROST PROOF



ESPESOR/THICKNESS:
120X120 - 11,5mm/0,45"
60X120 - 10,5mm/0,41"
30X60 - 10mm/0,39"
60X60 - 10mm/0,39"

Wabi Sabi

A combined style for the swimming pool and the whole house.

Un estilo combinado en la piscina y en toda la casa.

We present Wabi Sabi, a collection that reflects our commitment to design.

Wabi Sabi is one of APE GRUPO's most complete collections. Its materials, finishes, formats and textures has been meticulously studied and crafted so that all the pieces coexist in the same environment, creating spaces adapted to each client.

Wabi Sabi's goal is to offer a collection that allows us to work in a project of any domain from beginning to end.

It is a collection capable of adapting to all rooms. It allows us to combine stone, marble and wood, as well as colors and finishes, with the security of giving homogeneity to the project. Each combination offers a different personality.

Presentamos Wabi Sabi, una colección que refleja nuestro compromiso con el diseño.

Wabi Sabi es una de las colecciones más completas de APE GRUPO. El estudio de materiales, acabados, formatos y texturas que la componen han sido minuciosamente trabajadas para que todas las piezas convivan en el mismo entorno, creando espacios adaptados a cada cliente.

El objetivo de Wabi Sabi es ofrecer una colección que permita trabajar un proyecto de cualquier ámbito de principio a fin.

Se trata de una colección capaz de adaptarse a todas las estancias; permite combinar piedra, mármol y maderas, así como colores y acabados con la seguridad de dar homogeneidad al proyecto. Cada combinación ofrece una personalidad diferente

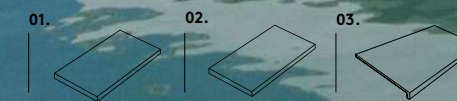

01. OXFORD C3 SLATE 33X66, 5/13\"X26\" 02. STRU. WABI TAUPE RECT. 60X120/24\"X48\" 03. PELDAÑO RECTO ANT. C3 WABI TAUPE 33X120X3/13\"X48\"X1\"

Wabi Sabi

APE

Wabi Sabi Pools

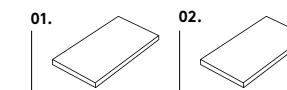

- 01. WABI SABBIA LAPATTO RECT 60X120/24"X48"
- 02. STRU WABI SABBIA RECT 60X120/24"X48"

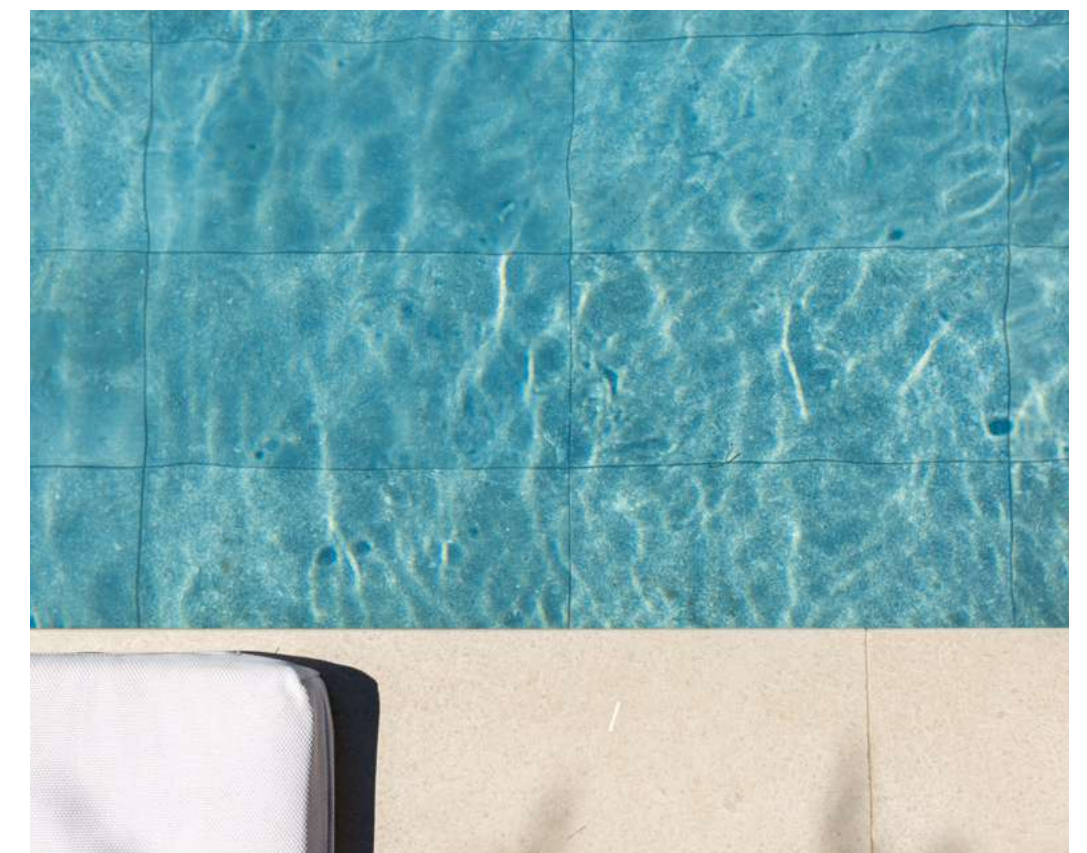

Wabi Sabi

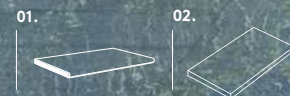

01. BORDE SKIMMER TRAVERTINO BRESCIA 45X75/18"X30" 02. TRAVERTINO BRESCIA STRUJ. RECT. 60X120/24"X48"

Wabi Sabi



01. STRU WABI TAUPE RECT. 60X60/24"X24" 02. BORDE DESBORDANTE WABI TAUPE 28X66,5/11"X26" 03. REJILLA WABI TAUPE 24,5X24,5/9,4"X9,4"
 04. WABI TAUPE LAP. RECT. 30X60/12"X24" 05. PELDAÑO RECTO ANT. C3 WABI TAUPE 33X120X3/13"X48"X1" 06. ANTI-SLIP MADAGASCAR NOCE RECT. 20X120/8"X48"
 07. PELDAÑO RECTO ANT. MADAGASCAR NOCE 33X120/13"X48"

Wabi Sabi is one of the most complete collections. It allows us to create traditional and overflow pools, and is conceived to accompany the user throughout the whole project.

Wabi Sabi es una de las colecciones más completas. No solo permite crear piscinas tradicionales y desbordantes, sino que está especialmente pensada para acompañar al usuario en todo el proyecto.



Wabi Sabi

APE

Wabi Sabi Pools

PELDAÑO RECTO WABI



C3 PELDAÑO RECTO ANT. C3 WABI BIANCO 33 X 120 / 13" X 48" **K91/P** **C3** PELDAÑO RECTO ANT. C3 WABI GRAFITE 33 X 120 / 13" X 48" **K91/P** **C3** PELDAÑO RECTO ANT. C3 WABI SABBIA 33 X 120 / 13" X 48" **K91/P** **C3** PELDAÑO RECTO ANT. C3 WABI TAUPE 33 X 120 / 13" X 48" **K91/P**



ZANQUIN RECTO DCHA./IZQ. WABI BIANCO 7,5 X 60 / 3" X 24" **K09/P** ZANQUIN RECTO DCHA./IZQ. WABI GRAFITE 7,5 X 60 / 3" X 24" **K09/P** ZANQUIN RECTO DCHA./IZQ. WABI SABBIA 7,5 X 60 / 3" X 24" **K09/P** ZANQUIN RECTO DCHA./IZQ. WABI TAUPE 7,5 X 60 / 3" X 24" **K09/P**

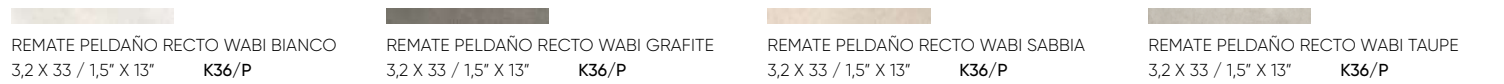

REMATE PELDAÑO RECTO WABI BIANCO 3,2 X 33 / 1,5" X 13" **K36/P** REMATE PELDAÑO RECTO WABI GRAFITE 3,2 X 33 / 1,5" X 13" **K36/P** REMATE PELDAÑO RECTO WABI SABBIA 3,2 X 33 / 1,5" X 13" **K36/P** REMATE PELDAÑO RECTO WABI TAUPE 3,2 X 33 / 1,5" X 13" **K36/P**



TABICA WABI BIANCO 15 X 120 / 6" X 48" **K11/P** TABICA WABI GRAFITE 15 X 120 / 6" X 48" **K11/P** TABICA WABI SABBIA 15 X 120 / 6" X 48" **K11/P** TABICA WABI TAUPE 15 X 120 / 6" X 48" **K11/P**

PELDAÑO RECTO TRAVERTINO



C3 PELDAÑO RECTO ANT. C3 TRAVERTINO SILVER 33 X 120 / 13" X 48" **K91/P** **C3** PELDAÑO RECTO ANT. C3 TRAVERTINO BRESCIA 33 X 120 / 13" X 48" **K91/P**

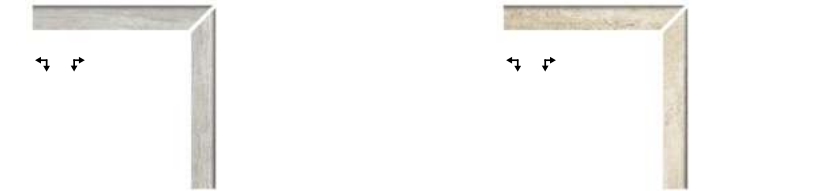

ZANQUIN RECTO DCHA./IZQ. TRAVERTINO SILVER MATT 7,5 X 60 / 3" X 24" **K09/P** ZANQUIN RECTO DCHA./IZQ. TRAVERTINO BRESCIA MATT 7,5 X 60 / 3" X 24" **K09/P** ZANQUIN RECTO DCHA./IZQ. MADAGASCAR NOCE 10 X 60 / 4" X 24" **K09/P**

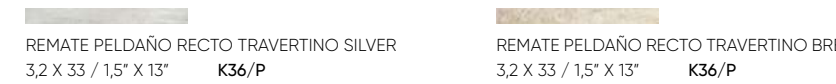

REMATE PELDAÑO RECTO TRAVERTINO SILVER 3,2 X 33 / 1,5" X 13" **K36/P** REMATE PELDAÑO RECTO TRAVERTINO BRESCIA 3,2 X 33 / 1,5" X 13" **K36/P**

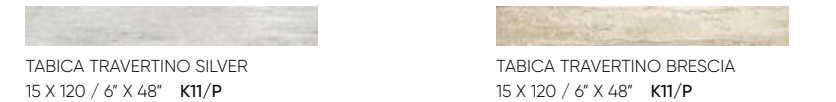

TABICA TRAVERTINO SILVER 15 X 120 / 6" X 48" **K11/P** TABICA TRAVERTINO BRESCIA 15 X 120 / 6" X 48" **K11/P** TABICA MADAGASCAR NOCE 15 X 120 / 6" X 48" **K11/P**

PELDAÑO RECTO MADAGASCAR



C3 PELDAÑO RECTO ANT. C3 MADAGASCAR NOCE 33 X 120 / 13" X 48" **K91/P**



ZANQUIN RECTO DCHA./IZQ. MADAGASCAR NOCE 10 X 60 / 4" X 24" **K09/P**



REMATE PELDAÑO RECTO MADAGASCAR NOCE 3,2 X 33 / 1,5" X 13" **K36/P**



TABICA MADAGASCAR NOCE 15 X 120 / 6" X 48" **K11/P**

PELDAÑO FIORENTINO TRAVERTINO



C3 PELDAÑO FIOR. ANT. C3 TRAVERTINO SILVER 33X120 / 13"X48" **K91/P** **C3** PELDAÑO FIOR. ANT. C3 TRAVERTINO BRESCIA 33X120 / 13"X48" **K91/P**



REMATE FIOR. IZQ. PELD. TRAVERTINO SILVER 3,2X33 / 1,5"X13" **K36/P** REMATE FIOR. IZQ. PELD. TRAVERTINO BRESCIA 3,2X33 / 1,5"X13" **K36/P**



REMATE FIOR. DER. PELD. TRAVERTINO SILVER 3,2X33 / 1,5"X13" **K36/P** REMATE FIOR. DER. PELD. TRAVERTINO BRESCIA 3,2X33 / 1,5"X13" **K36/P**

CARACTERÍSTICAS TÉCNICAS · TECHNICAL CHARACTERISTICS

-  EXTRUSIONADO/EXTRUDED KLINKER
-  MATE/MATT
-  RECTIFICADO/RECTIFIED
-  VARIACION LEVE/SLIGHT VARIATION
-  ANTI-SLIP R11
-  (DCOF) >0.50
-  CLASE 3/CLASS 3
-  ANTI-SLIP BAREFOOT A+B+C

-  DORSO ESTRIADO EN COLA DE MILANO. DOVE TAIL PROFILE.
-  JUNTA RECOMENDADA 5 MM. RECOMMENDED JOINT BETWEEN PIECES 5 MM.

Wabi Sabi

APE

Wabi Sabi Pools

OVERFLOW POOL / PISCINA DESBORDANTE

WABI



BORDE DESBORDANTE WABI BIANCO
28 X 66,5 / 11" X 26" K94/P



BORDE DESBORDANTE WABI SABBIA
28 X 66,5 / 11" X 26" K94/P



BORDE DESBORDANTE WABI TAUPE
28 X 66,5 / 11" X 26" K94/P



REJILLA WABI BIANCO
24,5 X 24,5 / 9,4" X 9,4" K57/P



REJILLA WABI SABBIA
24,5 X 24,5 / 9,4" X 9,4" K57/P



REJILLA WABI TAUPE
24,5 X 24,5 / 9,4" X 9,4" K57/P



MEDIA CAÑA WABI BIANCO
4 X 33 / 1,5" X 13" K29/P



MEDIA CAÑA WABI SABBIA
4 X 33 / 1,5" X 13" K29/P



MEDIA CAÑA WABI TAUPE
4 X 33 / 1,5" X 13" K29/P



ARISTA WABI BIANCO
4 X 33 / 1,5" X 13" K29/P



ARISTA WABI SABBIA
4 X 33 / 1,5" X 13" K29/P



ARISTA WABI TAUPE
4 X 33 / 1,5" X 13" K29/P



UÑA ARISTA WABI BIANCO
3 X 3 / 1,2" X 1,2" K06/P



UÑA ARISTA WABI SABBIA
3 X 3 / 1,2" X 1,2" K06/P



UÑA ARISTA WABI TAUPE
3 X 3 / 1,2" X 1,2" K06/P



UÑA CAÑA WABI BIANCO
4 X 4 / 1,5" X 1,5" K06/P



UÑA CAÑA WABI SABBIA
4 X 4 / 1,5" X 1,5" K06/P



UÑA CAÑA WABI TAUPE
4 X 4 / 1,5" X 1,5" K06/P

TRADITIONAL POOL / PISCINA TRADICIONAL

WABI



BORDE SKIMMER WABI BIANCO
45 X 75 / 18" X 30" K93/P



BORDE SKIMMER WABI SABBIA
45 X 75 / 18" X 30" K93/P



BORDE SKIMMER WABI TAUPE
45 X 75 / 18" X 30" K93/P

OVERFLOW POOL / PISCINA DESBORDANTE

TRAVERTINO



BORDE DESBORDANTE TRAVERTINO SILVER
28 X 66,5 / 11" X 26" K94/P



BORDE DESBORDANTE TRAVERTINO BRESCIA
28 X 66,5 / 11" X 26" K94/P



REJILLA TRAVERTINO SILVER
24,5 X 24,5 / 9,4" X 9,4" K57/P



REJILLA TRAVERTINO BRESCIA
24,5 X 24,5 / 9,4" X 9,4" K57/P



MEDIA CAÑA TRAVERTINO SILVER
4 X 33 / 1,5" X 13" K29/P



MEDIA CAÑA TRAVERTINO BRESCIA
4 X 33 / 1,5" X 13" K29/P



ARISTA TRAVERTINO SILVER
4 X 33 / 1,5" X 13" K29/P



ARISTA TRAVERTINO BRESCIA
4 X 33 / 1,5" X 13" K29/P



UÑA ARISTA TRAVERTINO SILVER
3 X 3 / 1,2" X 1,2" K06/P



UÑA ARISTA TRAVERTINO BRESCIA
3 X 3 / 1,2" X 1,2" K06/P



UÑA CAÑA TRAVERTINO SILVER
4 X 4 / 1,5" X 1,5" K06/P



UÑA CAÑA TRAVERTINO BRESCIA
4 X 4 / 1,5" X 1,5" K06/P

TRADITIONAL POOL / PISCINA TRADICIONAL

TRAVERTINO



BORDE SKIMMER TRAVERTINO SILVER
45 X 75 / 18" X 30" K93/P



BORDE SKIMMER TRAVERTINO BRESCIA
45 X 75 / 18" X 30" K93/P

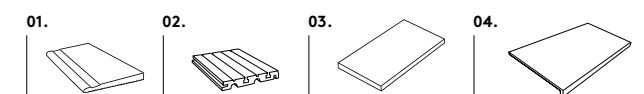
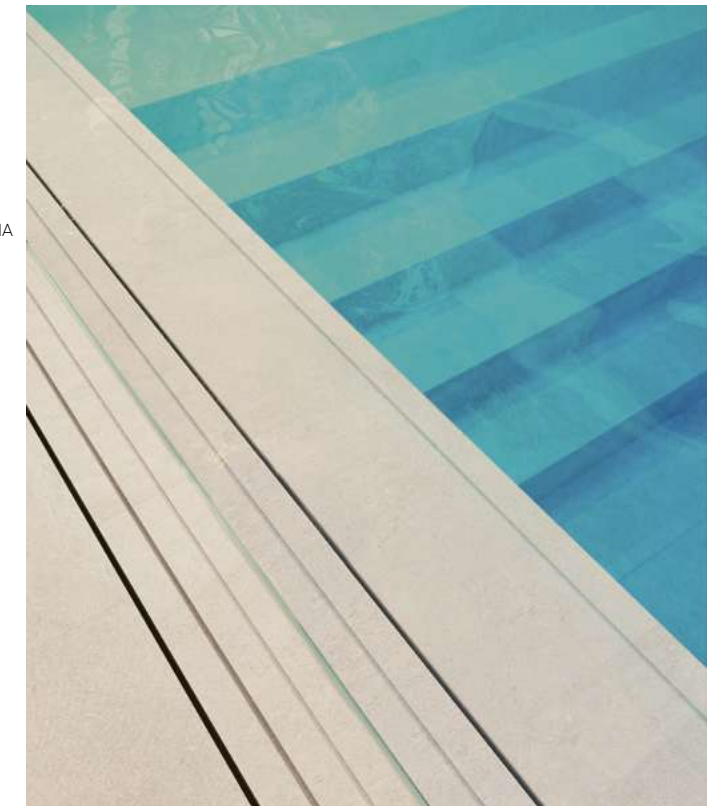

- 01. BORDE DESBORDANTE WABI SABBIA 28X66,5/11"X26"
- 02. REJILLA WABI SABBIA 24,5X24,5/9,4"X9,4"
- 03. STRU WABI SABBIA RECT. 60X120/24"X48"
- 04. PELDAÑO RECTO ANT. C3 WABI SABBIA 33X120/13"X48"

CARACTERÍSTICAS TÉCNICAS - TECHNICAL CHARACTERISTICS

- E** EXTRUSIONADO/EXTRUDED KLINKER
- M** MATE/MATT
- V2** VARIACION LEVE/SLIGHT VARIATION
- R11** ANTI-SLIP R11
- (DCOF) >0.50**
- C3** CLASE 3/CLASS 3
- A+B+C** ANTI-SLIP BAREFOOT A+B+C

- DORSO ESTRIADO EN COLA DE MILANO. DOVE TAIL PROFILE.**
- JUNTA RECOMENDADA 5 MM. RECOMMENDED JOINT BETWEEN PIECES 5 MM.**



Wabi Sabi



APE

Wabi Sabi Pools



PELDAÑO RECTO WABI



BORDE SKIMMER WABI



PELDAÑO FIOR. ANT. TRAVERTINO



BORDE DESBORDANTE TRAVERTINO



REJILLA TRAVERTINO

Wabi Sabi

BASES

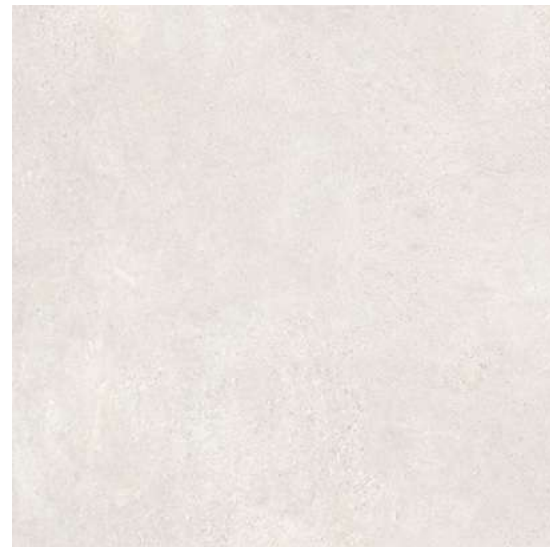

C2 R10 WABI BIANCO LAPATTO RECT.
120 X 120 / 48" X 48"

P05/M

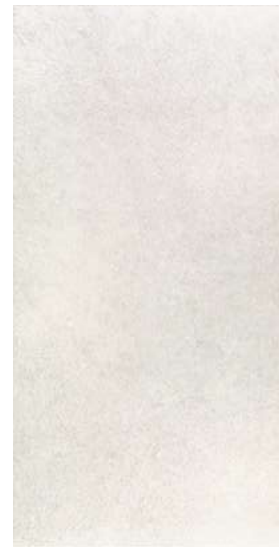

M C3 R11 STRU WABI BIANCO RECT.
60 X 120 / 24" X 48"

N74/M

C2 R10 WABI BIANCO LAPATTO RECT.
60 X 120 / 24" X 48"

N37/M

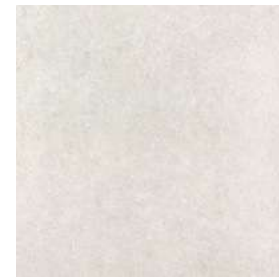

M C3 R11 STRU WABI BIANCO RECT.
60 X 60 / 24" X 24"

N33/M

C2 R10 WABI BIANCO LAPATTO RECT.
60 X 60 / 24" X 24"

N43/M



M C3 R11 STRU WABI BIANCO RECT.
30 X 60 / 12" X 24"

N33/M

C2 R10 WABI BIANCO LAPATTO RECT.
30 X 60 / 12" X 24"

N43/M



V3 MADAGASCAR NOCE RECT.
20 X 120 / 8" X 48"

R52/M

C3 R11 V3 ANTI-SLIP MADAGASCAR NOCE RECT.
20 X 120 / 8" X 48"

N72/M



V4 MACCHIATO BIANCO RECT.
20 X 120 / 8" X 48"

R52/M



V3 MADAGASCAR BIANCO RECT.
20 X 120 / 8" X 48"

R52/M



V3 SABI BIANCO RECT.
75 X 75 / 30" X 30"

N47/M



V3 SABI NOCE RECT.
75 X 75 / 30" X 30"

N47/M

APE

Wabi Sabi Pools

BASES



M RU5 INVISIBLE GOLD MATT RECT.
120 X 120 / 48" X 48"

N31/M

M C2 RU5 INVISIBLE GOLD C2 RECT.
120 X 120 / 48" X 48"

N34/M

RU4 INVISIBLE GOLD POL. RECT.
120 X 120 / 48" X 48"

P06/M



M RU5 INVISIBLE GOLD MATT RECT.
60 X 120 / 24" X 48"

R60/M

M C2 RU5 INVISIBLE GOLD C2 RECT.
60 X 120 / 24" X 48"

N67/M

RU4 INVISIBLE GOLD POL. RECT.
60 X 120 / 24" X 48"

J18/M

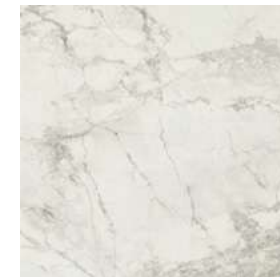

M RU5 INVISIBLE GOLD MATT RECT.
60 X 60 / 24" X 24"

P07/M

M C2 RU5 INVISIBLE GOLD C2 RECT.
60 X 60 / 24" X 24"

N18/M

RU4 INVISIBLE GOLD POL. RECT.
60 X 60 / 24" X 24"

N29/M

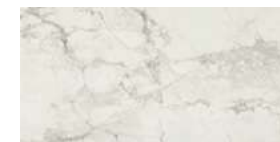

M RU5 INVISIBLE GOLD MATT RECT.
30 X 60 / 12" X 24"

P07/M

M C2 RU5 INVISIBLE GOLD C2 RECT.
30 X 60 / 12" X 24"

N18/M

RU4 INVISIBLE GOLD POL. RECT.
30 X 60 / 12" X 24"

N29/M

MOSAICOS · MOSAICS



Disponibile en todas los colores

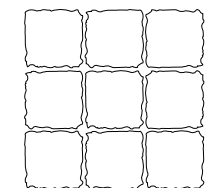

MOSAICO RUSTICO WABI
30 X 30 / 12" X 12" K63/P

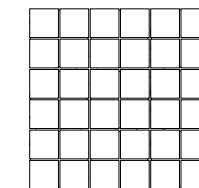

MOSAICO WABI
30 X 30 (5 X 5) / 12" X 12" K01/P

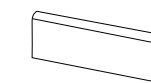

RODAPIÉ

WABI 7,5X60 / 3"X24" K24/P *

MADAGASCAR 10X120 / 4"X48" K02/P

INVISIBLE, TRAVERTINO, OROBICO POL. 7,5X60 / 3"X24" K29/P

INVISIBLE, TRAVERTINO, OROBICO POL. 7,5X120 / 3"X48" K08/P

INVISIBLE, TRAVERTINO, OROBICO MATT 7,5X60 / 3"X24" K24/P

INVISIBLE, TRAVERTINO, OROBICO MATT 7,5X120 / 3"X48" K02/P

STRU TRAVERTINO 7,5X60 / 3"X24" K24/P

* (DISPONIBLE EN TODOS LOS COLORES / AVAILABLE IN ALL COLORS)

CARACTERÍSTICAS TÉCNICAS · TECHNICAL CHARACTERISTICS

- P** PORCELÁNICO / PORCELAIN TILES
- R** RECTIFICADO / RECTIFIED
- V2** VARIACION LEVE / SLIGHT VARIATION
- M** MASA COLOREADA / COLORED BODY

- RU5** ANTIHIELO / FROST PROOF
- RU5** USO RECOMENDADO / RECOMMENDED USE - RU5
- R** ESPESOR / THICKNESS:
120X120 - 11,5mm / 0,45"
60X120 - 10,5mm / 0,41"
75X75 - 11mm / 0,43"
20X120 - 10mm / 0,39"
30X60 - 10mm / 0,39"

Wabi Sabi

BASES

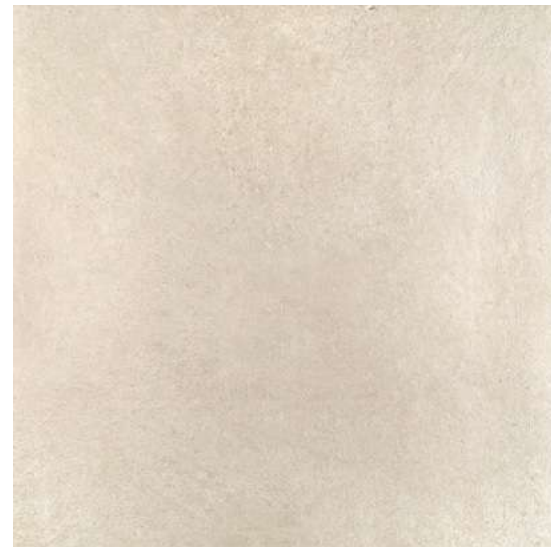

WABI SABBIA LAPATTO RECT.
120 X 120 / 48" X 48"

P05/M



STRU WABI SABBIA RECT.
60 X 120 / 24" X 48"

N74/M

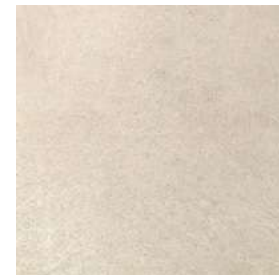

WABI SABBIA LAPATTO RECT.
60 X 60 / 24" X 24"

N43/M



STRU WABI SABBIA RECT.
30 X 60 / 12" X 24"

N33/M

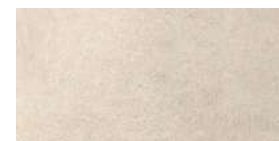

WABI SABBIA LAPATTO RECT.
30 X 60 / 12" X 24"

N43/M



STRU WABI SABBIA RECT.
20 X 120 / 8" X 48"

N72/M



MADAGASCAR NOCE RECT.
20 X 120 / 8" X 48"

R52/M



ANTI-SLIP MADAGASCAR NOCE RECT.
20 X 120 / 8" X 48"

N72/M



MACCHIATO SABBIA RECT.
20 X 120 / 8" X 48"

R52/M



MADAGASCAR SABBIA RECT.
20 X 120 / 8" X 48"

R52/M



SABI SABBIA RECT.
75 X 75 / 30" X 30"

N47/M



SABI NOCE RECT.
75 X 75 / 30" X 30"

N47/M

APE

Wabi Sabi Pools

BASES



TRAVERTINO BRESCIA POL. RECT.
120 X 120 / 48" X 48"

P06/M



TRAVERTINO BRESCIA MATT RECT.
60 X 120 / 24" X 48"

R60/M



TRAVERTINO BRESCIA C2 RECT.
60 X 120 / 24" X 48"

N67/M

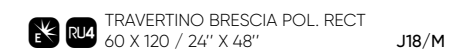

TRAVERTINO BRESCIA POL. RECT.
60 X 120 / 24" X 48"

J18/M



TRAVERTINO BRESCIA STRU RECT.
60 X 120 / 24" X 48"

N74/M



TRAVERTINO BRESCIA MATT RECT.
60 X 60 / 24" X 24"

P07/M



TRAVERTINO BRESCIA C2 RECT.
60 X 60 / 24" X 24"

N18/M



TRAVERTINO BRESCIA POL. RECT.
60 X 60 / 24" X 24"

N29/M



TRAVERTINO BRESCIA STRU RECT.
60 X 60 / 24" X 24"

N33/M



TRAVERTINO BRESCIA MATT RECT.
30 X 60 / 12" X 24"

P07/M



TRAVERTINO BRESCIA C2 RECT.
30 X 60 / 12" X 24"

N18/M



TRAVERTINO BRESCIA POL. RECT.
30 X 60 / 12" X 24"

N29/M



TRAVERTINO BRESCIA STRU RECT.
30 X 60 / 12" X 24"

N33/M

MOSAICOS · MOSAICS



Disponibile in todos los colores

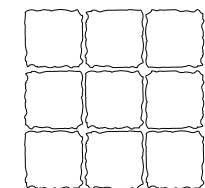

MOSAICO RUSTICO WABI
30 X 30 / 12" X 12" K63/P

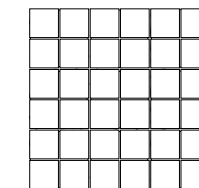

MOSAICO WABI
30 X 30 (5 X 5) / 12" X 12" K01/P

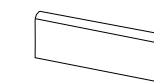

RODAPIÉ

WABI 7,5X60 / 3"X24" K24/P *

MADAGASCAR 10X120 / 4"X48" K02/P

INVISIBLE, TRAVERTINO, OROBICO POL. 7,5X60 / 3"X24" K29/P

INVISIBLE, TRAVERTINO, OROBICO POL. 7,5X120 / 3"X48" K08/P

INVISIBLE, TRAVERTINO, OROBICO MATT 7,5X60 / 3"X24" K24/P

INVISIBLE, TRAVERTINO, OROBICO MATT 7,5X120 / 3"X48" K02/P

STRU TRAVERTINO 7,5X60 / 3"X24" K24/P

* (DISPONIBLE EN TODOS LOS COLORES / AVAILABLE IN ALL COLORS)

CARACTERÍSTICAS TÉCNICAS · TECHNICAL CHARACTERISTICS

- P** PORCELÁNICO / PORCELAIN TILES
- R11** RECTIFICADO / RECTIFIED
- V2** VARIACION LEVE / SLIGHT VARIATION
- M** MASA COLOREADA / COLORED BODY

- RUS** ANTIHIELO / FROST PROOF
- RU5** USO RECOMENDADO / RECOMMENDED USE - RU5
- E** ESPESOR / THICKNESS:
120X120 - 11,5mm / 0,45"
60X120 - 10,5mm / 0,41"
75X75 - 11mm / 0,43"
20X120 - 10mm / 0,39"
30X60 - 10mm / 0,39"

Wabi Sabi

BASES

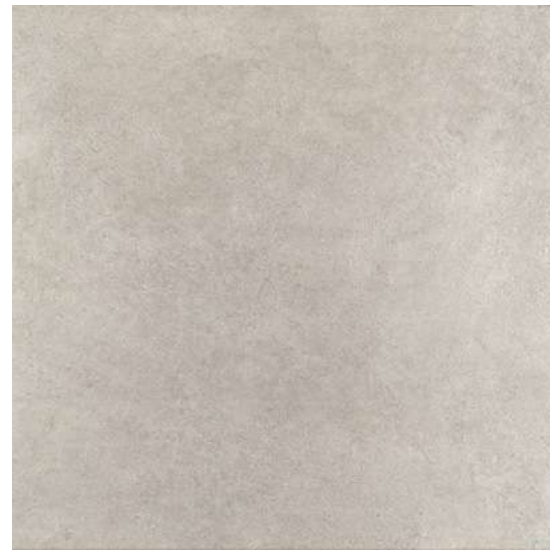

C2 R10 WABI TAUPE LAPATTO RECT.
120 X 120 / 48" X 48"

P05/M

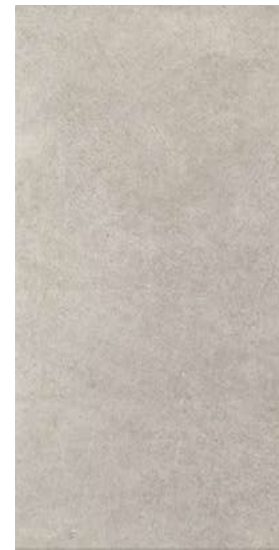

M C3 R11 STRU WABI TAUPE RECT.
60 X 120 / 24" X 48" N74/M

C2 R10 WABI TAUPE LAPATTO RECT.
60 X 120 / 24" X 48" N37/M

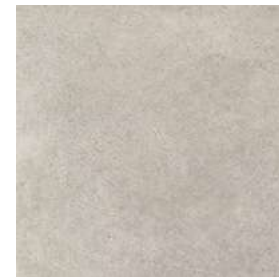

M C3 R11 STRU WABI TAUPE RECT.
60 X 60 / 24" X 24" N33/M

C2 R10 WABI TAUPE LAPATTO RECT.
60 X 60 / 24" X 24" N43/M

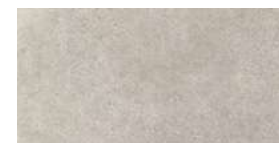

M C3 R11 STRU WABI TAUPE RECT.
30 X 60 / 12" X 24" N33/M

C2 R10 WABI TAUPE LAPATTO RECT.
30 X 60 / 12" X 24" N43/M



V3 MADAGASCAR NOCE RECT.
20 X 120 / 8" X 48"

R52/M

C3 R11 V3 ANTI-SLIP MADAGASCAR NOCE RECT.
20 X 120 / 8" X 48"

N72/M



V4 MACCHIATO TAUPE RECT.
20 X 120 / 8" X 48"

R52/M



V3 MADAGASCAR TAUPE RECT.
20 X 120 / 8" X 48"

R52/M



V3 SABI TAUPE RECT.
75 X 75 / 30" X 30"

N47/M



V3 SABI NOCE RECT.
75 X 75 / 30" X 30"

N47/M

APE

Wabi Sabi Pools

BASES



E RU4 TRAVERTINO SILVER POL. RECT.
120 X 120 / 48" X 48"

P06/M



M RU5 TRAVERTINO SILVER MATT RECT.
60 X 120 / 24" X 48"

R60/M

M C2 RU5 TRAVERTINO SILVER C2 RECT.
60 X 120 / 24" X 48"

N67/M

E RU4 TRAVERTINO SILVER POL. RECT.
60 X 120 / 24" X 48"

J18/M

M C3 R11 RU5 TRAVERTINO SILVER STRU RECT.
60 X 120 / 24" X 48"

N74/M



M RU5 TRAVERTINO SILVER MATT RECT.
60 X 60 / 24" X 24"

P07/M

M C2 RU5 TRAVERTINO SILVER C2 RECT.
60 X 60 / 24" X 24"

N18/M

E RU4 TRAVERTINO SILVER POL. RECT.
60 X 60 / 24" X 24"

N29/M

M C3 R11 RU5 TRAVERTINO SILVER STRU RECT.
60 X 60 / 24" X 24"

N33/M



M RU5 TRAVERTINO SILVER MATT RECT.
30 X 60 / 12" X 24"

P07/M

M C2 RU5 TRAVERTINO SILVER C2 RECT.
30 X 60 / 12" X 24"

N18/M

E RU4 TRAVERTINO SILVER POL. RECT.
30 X 60 / 12" X 24"

N29/M

M C3 R11 RU5 TRAVERTINO SILVER STRU RECT.
30 X 60 / 12" X 24"

N33/M

MOSAICOS · MOSAICS



Disponible en todos los colores

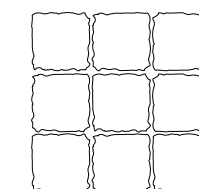

MOSAICO RUSTICO WABI
30 X 30 / 12" X 12" K63/P

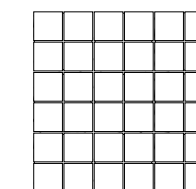

MOSAICO WABI
30 X 30 (5 X 5) / 12" X 12" K01/P

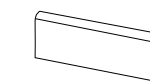

RODAPIÉ

WABI 7,5X60 / 3"X24" K24/P *

MADAGASCAR 10X120 / 4"X48" K02/P

INVISIBLE, TRAVERTINO, OROBICO POL. 7,5X60 / 3"X24" K29/P

INVISIBLE, TRAVERTINO, OROBICO POL. 7,5X120 / 3"X48" K08/P

INVISIBLE, TRAVERTINO, OROBICO MATT 7,5X60 / 3"X24" K24/P

INVISIBLE, TRAVERTINO, OROBICO MATT 7,5X120 / 3"X48" K02/P

STRU TRAVERTINO 7,5X60 / 3"X24" K24/P

* (DISPONIBLE EN TODOS LOS COLORES / AVAILABLE IN ALL COLORS)

CARACTERÍSTICAS TÉCNICAS · TECHNICAL CHARACTERISTICS

- P** PORCELÁNICO / PORCELAIN TILES
- R** RECTIFICADO / RECTIFIED
- V2** VARIACION LEVE / SLIGHT VARIATION
- M** MASA COLOREADA / COLORED BODY

- RUS** ANTIHIELO / FROST PROOF
- RU5** USO RECOMENDADO / RECOMMENDED USE - RU5
- E** ESPESOR / THICKNESS:
120X120 - 11,5mm / 0,45"
60X120 - 10,5mm / 0,41"
75X75 - 11mm / 0,43"
20X120 - 10mm / 0,39"
30X60 - 10mm / 0,39"

Wabi Sabi

BASES

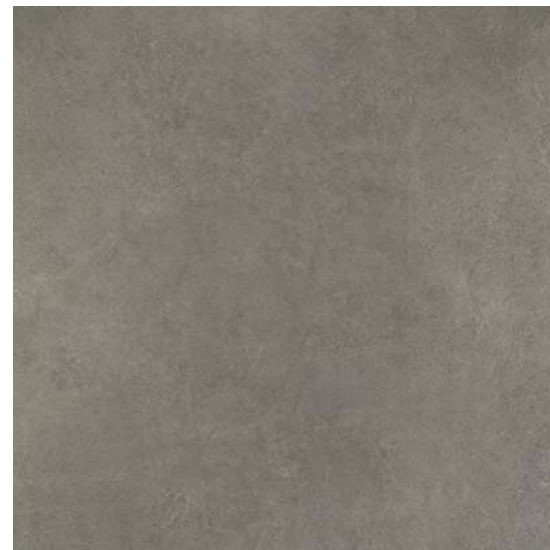

C2 R10 WABI GRAFITE LAPATTO RECT.
120 X 120 / 48" X 48"

P05/M



M C3 R11 STRU WABI GRAFITE RECT.
60 X 120 / 24" X 48" N74/M

*** C2 R10** WABI GRAFITE LAPATTO RECT.
60 X 120 / 24" X 48" N37/M



M C3 R11 STRU WABI GRAFITE RECT.
60 X 60 / 24" X 24" N33/M

*** C2 R10** WABI GRAFITE LAPATTO RECT.
60 X 60 / 24" X 24" N43/M



M C3 R11 STRU WABI GRAFITE RECT.
30 X 60 / 12" X 24" N33/M

*** C2 R10** WABI GRAFITE LAPATTO RECT.
30 X 60 / 12" X 24" N43/M



V3 MADAGASCAR NOCE RECT.
20 X 120 / 8" X 48"

R52/M

C3 R11 V3 ANTI-SLIP MADAGASCAR NOCE RECT.
20 X 120 / 8" X 48"

N72/M



V4 MACCHIATO GRAFITE RECT.
20 X 120 / 8" X 48"

R52/M



V3 MADAGASCAR GRAFITE RECT.
20 X 120 / 8" X 48"

R52/M



V3 SABI GRAFITE RECT.
75 X 75 / 30" X 30"

N47/M



V3 SABI NOCE RECT.
75 X 75 / 30" X 30"

N47/M

APE

Wabi Sabi Pools

BASES



M RU5 OROBICO GRIGIO MATT RECT.
120 X 120 / 48" X 48"

N31/M

M C2 RU5 OROBICO GRIGIO C2 RECT.
120 X 120 / 48" X 48"

N34/M

*** RU4** OROBICO GRIGIO POL. RECT.
120 X 120 / 48" X 48"

P06/M



M RU5 OROBICO GRIGIO MATT RECT.
60 X 120 / 24" X 48" R60/M

M C2 RU5 OROBICO GRIGIO C2 RECT.
60 X 120 / 24" X 48" N67/M

*** RU4** OROBICO GRIGIO POL. RECT.
60 X 120 / 24" X 48" J18/M

MOSAICOS · MOSAICS



Disponible en todos los colores

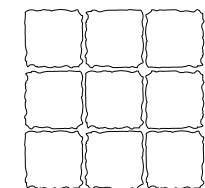

MOSAICO RUSTICO WABI
30 X 30 / 12" X 12" K63/P

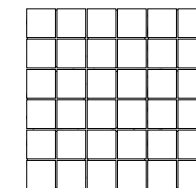

MOSAICO WABI
30 X 30 (5 X 5) / 12" X 12" K01/P

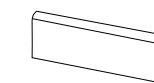

RODAPIÉ

WABI 7,5X60 / 3"X24" K24/P *

MADAGASCAR 10X120 / 4"X48" K02/P

INVISIBLE, TRAVERTINO, OROBICO POL. 7,5X60 / 3"X24" K29/P

INVISIBLE, TRAVERTINO, OROBICO POL. 7,5X120 / 3"X48" K08/P

INVISIBLE, TRAVERTINO, OROBICO MATT 7,5X60 / 3"X24" K24/P

INVISIBLE, TRAVERTINO, OROBICO MATT 7,5X120 / 3"X48" K02/P

STRU TRAVERTINO 7,5X60 / 3"X24" K24/P

* (DISPONIBLE EN TODOS LOS COLORES / AVAILABLE IN ALL COLORS)

CARACTERÍSTICAS TÉCNICAS · TECHNICAL CHARACTERISTICS

- P** PORCELÁNICO / PORCELAIN TILES
- R10** RECTIFICADO / RECTIFIED
- V2** VARIACION LEVE / SLIGHT VARIATION
- R11** MASA COLOREADA / COLORED BODY

- R11** ANTIHIELO / FROST PROOF
- RU5** USO RECOMENDADO / RECOMMENDED USE - RU5
- R12** ESPESOR / THICKNESS:
120X120 - 11,5mm / 0,45"
60X120 - 10,5mm / 0,41"
75X75 - 11mm / 0,43"
20X120 - 10mm / 0,39"
30X60 - 10mm / 0,39"

Work

An Italian collection ideal for swimming pools, terraces and indoors.

Colección de firma italiana ideal para piscinas, terrazas e interiores.

Fruit of the collaboration with the Italian architect Luigi Romanelli, we present the Work collection. Thanks to its special pieces, you can create both traditional and overflow pools. Its combination of concrete and wood and its variety of colors make it ideal not only for outdoors but also indoors.

Fruto de la colaboración con el arquitecto italiano Luigi Romanelli nace la colección Work. Gracias a sus piezas especiales se pueden crear piscinas tanto tradicionales como desbordantes. Su combinación de cementos y maderas y su variedad de colores la convierten en una colección ideal tanto para exteriores como para interiores.



- 01. ANTI-SLIP WORK B COAL RECT. 30X60/12"X24"
- 02. BORDE DESBORDANTE WORK B COAL 28X66,5/11"X26"
- 03. REJILLA WORK B COAL 24,5X24,5/9,4"X9,4"
- 04. MEDIA CAÑA WORK B COAL 4X33/1,5"X13"
- 05. PELDAÑO RECTO ANT. C3 WORK B COAL 33X120X3/13"X48"X1"
- 06. TABICA WORK B COAL 15X120/6"X48"
- 07. UNA CAÑA WORK B COAL 4X4/1,5"X1,5"
- 08. WORK W NATURAL RECT. 30X120/12"X48"

Work

APE

Work Pools

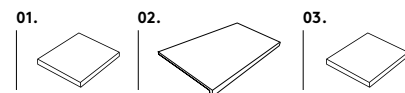

01. ANTI-SLIP WORK B TAUPE RECT. 90X90/36"X36" 02. PELDAÑO RECTO ANT. C3 WORK B TAUPE 33X120X3/13"X48"X1"
03. HIGH THICKNESS WORK B TAUPE RECT. 90X90/36"X36"

Work

PELDAÑO RECTO



C3 PELDAÑO RECTO ANT. C3 WORK B BIANCO 33 X 120 / 13" X 48" **K91/P** **C3** PELDAÑO RECTO ANT. C3 WORK B CENERE 33 X 120 / 13" X 48" **K91/P** **C3** PELDAÑO RECTO ANT. C3 WORK B COAL 33 X 120 / 13" X 48" **K91/P** **C3** PELDAÑO RECTO ANT. C3 WORK B TAUPE 33 X 120 / 13" X 48" **K91/P**



ZANQUIN RECTO DCHA./IZQ. WORK B BIANCO 8X60 / 3"X24" **K09/P** ZANQUIN RECTO DCHA./IZQ. WORK B CENERE 8X60 / 3"X24" **K09/P** ZANQUIN RECTO DCHA./IZQ. WORK B COAL 8X60 / 3"X24" **K09/P** ZANQUIN RECTO DCHA./IZQ. WORK B TAUPE 8X60 / 3"X24" **K09/P**

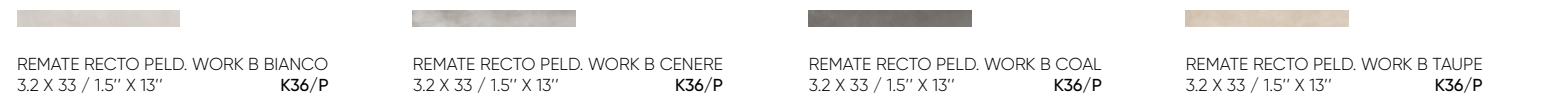

REMATE RECTO PELD. WORK B BIANCO 3.2 X 33 / 1.5" X 13" **K36/P** REMATE RECTO PELD. WORK B CENERE 3.2 X 33 / 1.5" X 13" **K36/P** REMATE RECTO PELD. WORK B COAL 3.2 X 33 / 1.5" X 13" **K36/P** REMATE RECTO PELD. WORK B TAUPE 3.2 X 33 / 1.5" X 13" **K36/P**

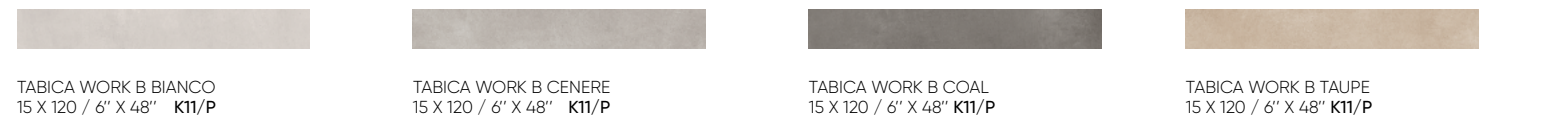

TABICA WORK B BIANCO 15 X 120 / 6" X 48" **K11/P** TABICA WORK B CENERE 15 X 120 / 6" X 48" **K11/P** TABICA WORK B COAL 15 X 120 / 6" X 48" **K11/P** TABICA WORK B TAUPE 15 X 120 / 6" X 48" **K11/P**

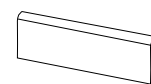

RODAPIÉ
WORK B 8X60 / 3"X24" **K24/P**
(DISPONIBLE EN TODOS LOS COLORES / AVAILABLE IN ALL COLORS)

CARACTERÍSTICAS TÉCNICAS · TECHNICAL CHARACTERISTICS

- E** EXTRUSIONADO/EXTRUDED KLINKER
- M** MATE/MATT
- R** RECTIFICADO/RECTIFIED
- V3** VARIACION MODERADA/MODERATE VARIATION
- R11** ANTI-SLIP R11
- D** (DCOF) >0.50
- C3** CLASE 3/CLASS 3
- A+B+C** ANTI-SLIP BAREFOOT A+B+C



DORSO ESTRIADO EN COLA DE MILANO.
DOVE TAIL PROFILE.



JUNTA RECOMENDADA 5 MM.
RECOMMENDED JOINT BETWEEN PIECES 5 MM.

Work

PELDAÑO RECTO



C3 PELDAÑO RECTO ANT. C3 WORK W NATURAL 33 X 120 / 13" X 48" **K91/P**

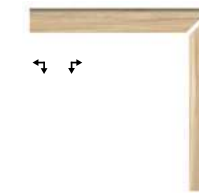

ZANQUIN RECTO DCHA./IZQ. WORK W NATURAL 7,5X60 / 3"X24" **K09/P**

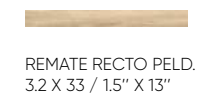

REMATE RECTO PELD. WORK W NATURAL 3.2 X 33 / 1.5" X 13" **K36/P**



TABICA WORK W NATURAL 15 X 120 / 6" X 48" **K11/P**

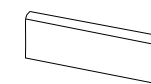

ROD. WORK W NATURAL 10X120 / 4"X48" **K02/P**
(DISPONIBLE EN TODOS LOS COLORES / AVAILABLE IN ALL COLORS)

BASES



R WORK W NATURAL RECT. 30 X 120 / 12" X 48" **P12/M**

R **C3** **R11** ANTI-SLIP WORK W NATURAL RECT. 30 X 120 / 12" X 48" **N24/M**



R WORK W NATURAL RECT. 20 X 120 / 8" X 48" **P12/M**

R **C3** **R11** ANTI-SLIP WORK W NATURAL RECT. 20 X 120 / 8" X 48" **N24/M**



C2 **R10** **V4** **R** HEXAWORK MIX 21 X 18.2 / 8" X 7" **N39/M**



C2 **R10** HEXAWORK W NATURAL 21 X 18.2 / 8" X 7" **P03/M**

CARACTERÍSTICAS TÉCNICAS · TECHNICAL CHARACTERISTICS

- P** PORCELÁNICO/PORCELAIN TILES
- M** MATE/MATT
- R** RECTIFICADO/RECTIFIED
- M** MASA COLOREADA/COLORED BODY
- V2** VARIACION LEVE/SLIGHT VARIATION
- V4** VARIACION FUERTE/SUBSTANTIAL VARIATION
- E** ESPESOR/THICKNESS: 10,5mm/0,41"

Work

APE

Work Pools

OVERFLOW POOL / PISCINA DESBORDANTE



POOL EDGE HIGH THICKNESS
WORK B BIANCO
90 X 90/36" X 36" **K93/P**
* Espesor 20mm / thickness 0,8"

POOL EDGE HIGH THICKNESS
WORK B CENERE
90 X 90/36" X 36" **K93/P**
* Espesor 20mm / thickness 0,8"

POOL EDGE HIGH THICKNESS
WORK B COAL
90 X 90/36" X 36" **K93/P**
* Espesor 20mm / thickness 0,8"

POOL EDGE HIGH THICKNESS
WORK B TAUPE
90 X 90/36" X 36" **K93/P**
* Espesor 20mm / thickness 0,8"



BORDE DESBORDANTE WORK B BIANCO
28 X 66.5 / 11" X 26" **K94/P**



BORDE DESBORDANTE WORK B CENERE
28 X 66.5 / 11" X 26" **K94/P**



BORDE DESBORDANTE WORK B COAL
28 X 66.5 / 11" X 26" **K94/P**



BORDE DESBORDANTE WORK B TAUPE
28 X 66.5 / 11" X 26" **K94/P**



REJILLA WORK B BIANCO
24.5 X 24.5 / 9.4" X 9.4" **K57/P**



REJILLA WORK B CENERE
24.5 X 24.5 / 9.4" X 9.4" **K57/P**



REJILLA WORK B COAL
24.5 X 24.5 / 9.4" X 9.4" **K57/P**



REJILLA WORK B TAUPE
24.5 X 24.5 / 9.4" X 9.4" **K57/P**



MEDIA CAÑA WORK B BIANCO
4 X 33 / 1.5" X 13" **K29/P**



MEDIA CAÑA WORK B CENERE
4 X 33 / 1.5" X 13" **K29/P**



MEDIA CAÑA WORK B COAL
4 X 33 / 1.5" X 13" **K29/P**



MEDIA CAÑA WORK B TAUPE
4 X 33 / 1.5" X 13" **K29/P**



ARISTA WORK B BIANCO
4 X 33 / 1.5" X 13" **K29/P**



ARISTA WORK B CENERE
4 X 33 / 1.5" X 13" **K29/P**



ARISTA WORK B COAL
4 X 33 / 1.5" X 13" **K29/P**



ARISTA WORK B TAUPE
4 X 33 / 1.5" X 13" **K29/P**



UÑA ARISTA WORK B BIANCO
3 X 3 / 1.5" X 1.5" **K06/P**



UÑA ARISTA WORK B CENERE
3 X 3 / 1.5" X 1.5" **K06/P**



UÑA ARISTA WORK B COAL
3 X 3 / 1.5" X 1.5" **K06/P**



UÑA ARISTA WORK B TAUPE
3 X 3 / 1.5" X 1.5" **K06/P**



UÑA CAÑA WORK B BIANCO
4 X 4 / 1.5" X 1.5" **K06/P**



UÑA CAÑA WORK B CENERE
4 X 4 / 1.5" X 1.5" **K06/P**



UÑA CAÑA WORK B COAL
4 X 4 / 1.5" X 1.5" **K06/P**



UÑA CAÑA WORK B TAUPE
4 X 4 / 1.5" X 1.5" **K06/P**



PELDAÑO RECTO WORK W NATURAL



BORDE DESBORDANTE WORK



HIGH THICKNESS/ESPESORADO



REJILLA WORK

CARACTERÍSTICAS TÉCNICAS · TECHNICAL CHARACTERISTICS

- E** EXTRUSIONADO/EXTRUDED KLINKER
- M** MATE/MATT
- V3** VARIACION MODERADA/MODERATE VARIATION
- R11** ANTI-SLIP R11
- (Dcof) >0.50**
- C3** CLASE 3/CLASS 3
- ANTI-SLIP BAREFOOT A+B+C**

- DORSO ESTRIADO EN COLA DE MILANO. DOVE TAIL PROFILE.**
- JUNTA RECOMENDADA 5 MM. RECOMMENDED JOINT BETWEEN PIECES 5 MM.**



Work

BASES

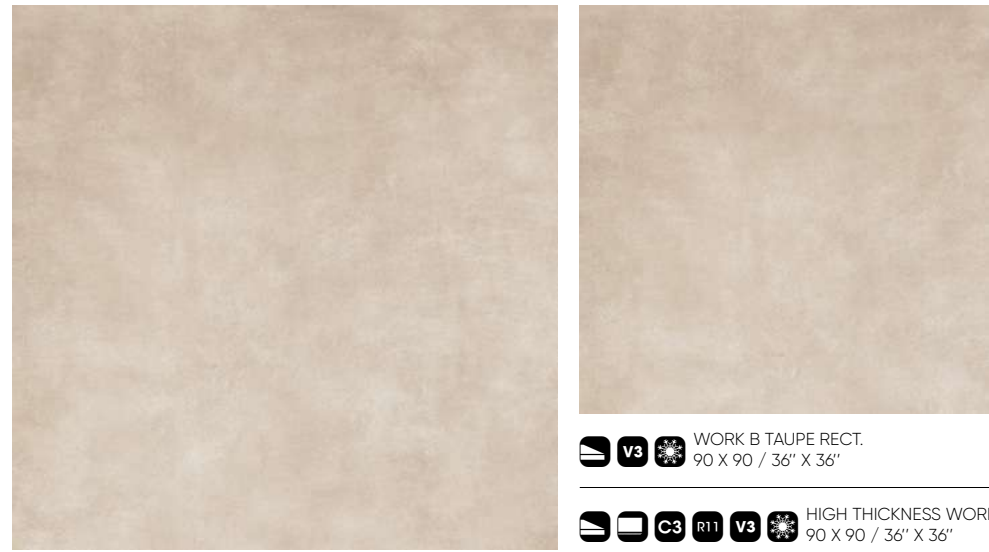

WORK B TAUPE RECT.
90 X 90 / 36" X 36" **P09/M**

HIGH THICKNESS WORK B TAUPE RECT.
90 X 90 / 36" X 36" **N05/M**

WORK B TAUPE RECT.
120 X 120 / 48" X 48" **P08/M**

ANTI-SLIP WORK B TAUPE RECT.
90 X 90 / 36" X 36" **P18/M**

WORK B TAUPE RECT.
60 X 120 / 24" X 48" **P11/M**

WORK B TAUPE RECT.
60 X 60 / 24" X 24" **P16/M**

WORK B TAUPE RECT.
30 X 60 / 12" X 24" **P16/M**

ANTI-SLIP WORK B TAUPE RECT.
60 X 120 / 24" X 48" **P01/M**

ANTI-SLIP WORK B TAUPE RECT.
60 X 60 / 24" X 24" **P02/M**

ANTI-SLIP WORK B TAUPE RECT.
30 X 60 / 12" X 24" **P02/M**

MOSAICO WORK TAUPE
30 X 30 (5 X 5) / 12" X 12" **K01/P**

HEXAWORK B TAUPE
21 X 18.2 / 8" X 7" **P03/M**

**Espesor 20mm / thickness 0.8"*

APE

Work Pools

BASES

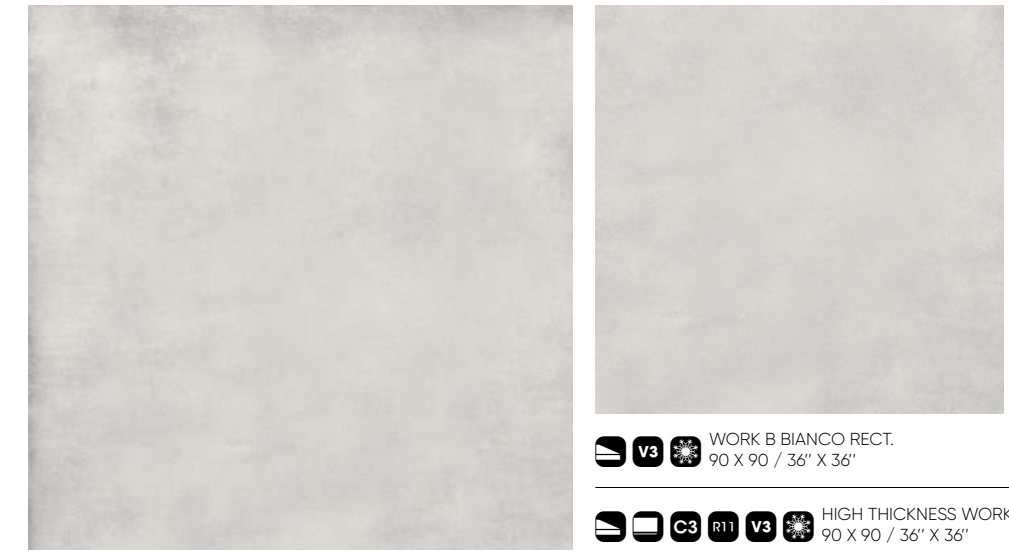

WORK B BIANCO RECT.
90 X 90 / 36" X 36" **P09/M**

HIGH THICKNESS WORK B BIANCO RECT.
90 X 90 / 36" X 36" **N05/M**

WORK B BIANCO RECT.
120 X 120 / 48" X 48" **P08/M**

ANTI-SLIP WORK B BIANCO RECT.
90 X 90 / 36" X 36" **P18/M**

WORK B BIANCO RECT.
60 X 120 / 24" X 48" **P11/M**

WORK B BIANCO RECT.
60 X 60 / 24" X 24" **P16/M**

WORK B BIANCO RECT.
30 X 60 / 12" X 24" **P16/M**

ANTI-SLIP WORK B BIANCO RECT.
60 X 120 / 24" X 48" **P01/M**

ANTI-SLIP WORK B BIANCO RECT.
60 X 60 / 24" X 24" **P02/M**

ANTI-SLIP WORK B BIANCO RECT.
30 X 60 / 12" X 24" **P02/M**

MOSAICO WORK BIANCO
30 X 30 (5 X 5) / 12" X 12" **K01/P**

HEXAWORK B BIANCO
21 X 18.2 / 8" X 7" **P03/M**

**Espesor 20mm / thickness 0.8"*

CARACTERÍSTICAS TÉCNICAS · TECHNICAL CHARACTERISTICS

- P** PORCELÁNICO / PORCELAIN TILES
- M** MATE / MATT
- MASA COLOREADA / COLORED BODY**
- RU5** USO RECOMENDADO / RECOMMENED USE - RU5
- ESPEJOR / THIKNESS:**
10,5mm / 0,41"
90X90 - 10mm / 0,39"
90X90 - 20mm / 0,79"

Work

BASES

WORK B CENERE RECT.
90 X 90 / 36" X 36" **P09/M**

HIGH THICKNESS WORK B CENERE RECT.*
90 X 90 / 36" X 36" **N05/M**

WORK B CENERE RECT.
120 X 120 / 48" X 48" **P08/M**

ANTI-SLIP WORK B CENERE RECT.
90 X 90 / 36" X 36" **P18/M**

WORK B CENERE RECT.
60 X 120 / 24" X 48" **P11/M**

WORK B CENERE RECT.
60 X 60 / 24" X 24" **P16/M**

WORK B CENERE RECT.
30 X 60 / 12" X 24" **P16/M**

ANTI-SLIP WORK B CENERE RECT.
60 X 120 / 24" X 48" **P01/M**

ANTI-SLIP WORK B CENERE RECT.
60 X 60 / 24" X 24" **P02/M**

ANTI-SLIP WORK B CENERE RECT.
30 X 60 / 12" X 24" **P02/M**

MOSAICO WORK CENERE
30 X 30 (5 X 5) / 12" X 12" **K01/P**

HEXAWORK B CENERE
21 X 18.2 / 8" X 7" **P03/M**

**Espesor 20mm / thickness 0.8"*

APE

Work Pools

BASES

WORK B COAL RECT.
90 X 90 / 36" X 36" **P09/M**

HIGH THICKNESS WORK B COAL RECT.*
90 X 90 / 36" X 36" **N05/M**

WORK B COAL RECT.
120 X 120 / 48" X 48" **P08/M**

ANTI-SLIP WORK B COAL RECT.
90 X 90 / 36" X 36" **P18/M**

WORK B COAL RECT.
60 X 120 / 24" X 48" **P11/M**

WORK B COAL RECT.
60 X 60 / 24" X 24" **P16/M**

WORK B COAL RECT.
30 X 60 / 12" X 24" **P16/M**

ANTI-SLIP WORK B COAL RECT.
60 X 120 / 24" X 48" **P01/M**

ANTI-SLIP WORK B COAL RECT.
60 X 60 / 24" X 24" **P02/M**

ANTI-SLIP WORK B COAL RECT.
30 X 60 / 12" X 24" **P02/M**

MOSAICO WORK COAL
30 X 30 (5 X 5) / 12" X 12" **K01/P**

HEXAWORK B COAL
21 X 18.2 / 8" X 7" **P03/M**

**Espesor 20mm / thickness 0.8"*

CARACTERÍSTICAS TÉCNICAS · TECHNICAL CHARACTERISTICS

- P** PORCELÁNICO / PORCELAIN TILES
- M** MATE / MATT
- MASA COLOREADA / COLORED BODY**
- RU5** USO RECOMENDADO / RECOMMENED USE - RUS
- ESPEJOR / THIKNESS:**
10,5mm / 0,41"
90X90 - 10mm / 0,39"
90X90 - 20mm / 0,79"



collections

colecciones

PUBLIC POOLS / PISCINAS PÚBLICAS

Dots

150

Grooved

152

Dots

Overflow pool.

Dots collection is a covering for swimming pools with overflowing system , that gives perfect solutions for the most complicated areas of multi-use swimming pools and public sport facilities. Moreover, it guarantees optimum security.

Some of the benefits of this system are:

Omnidirectional anti-slipping. Homogeneous and safer compared with other grooved reliefs.

Easy laying and faster cleaning of the grout.

Easy and safe maintenance, thanks to the relief design.

Piscina desbordante.

La colección Dots es un recubrimiento para piscinas, con sistema de coronación desbordante, que da óptimas soluciones a las zonas más complejas de piscinas polivalentes e instalaciones deportivas de uso público. Garantizando la máxima seguridad de manera homogénea.

Algunas ventajas de este sistema:

Antideslizamiento omnidireccional, homogéneo y más seguro, frente a otros relieves ranurados.

Fácil colocación y limpieza del rejuntado más rápida.

Mantenimiento rápido y seguro, debido al diseño del relieve.

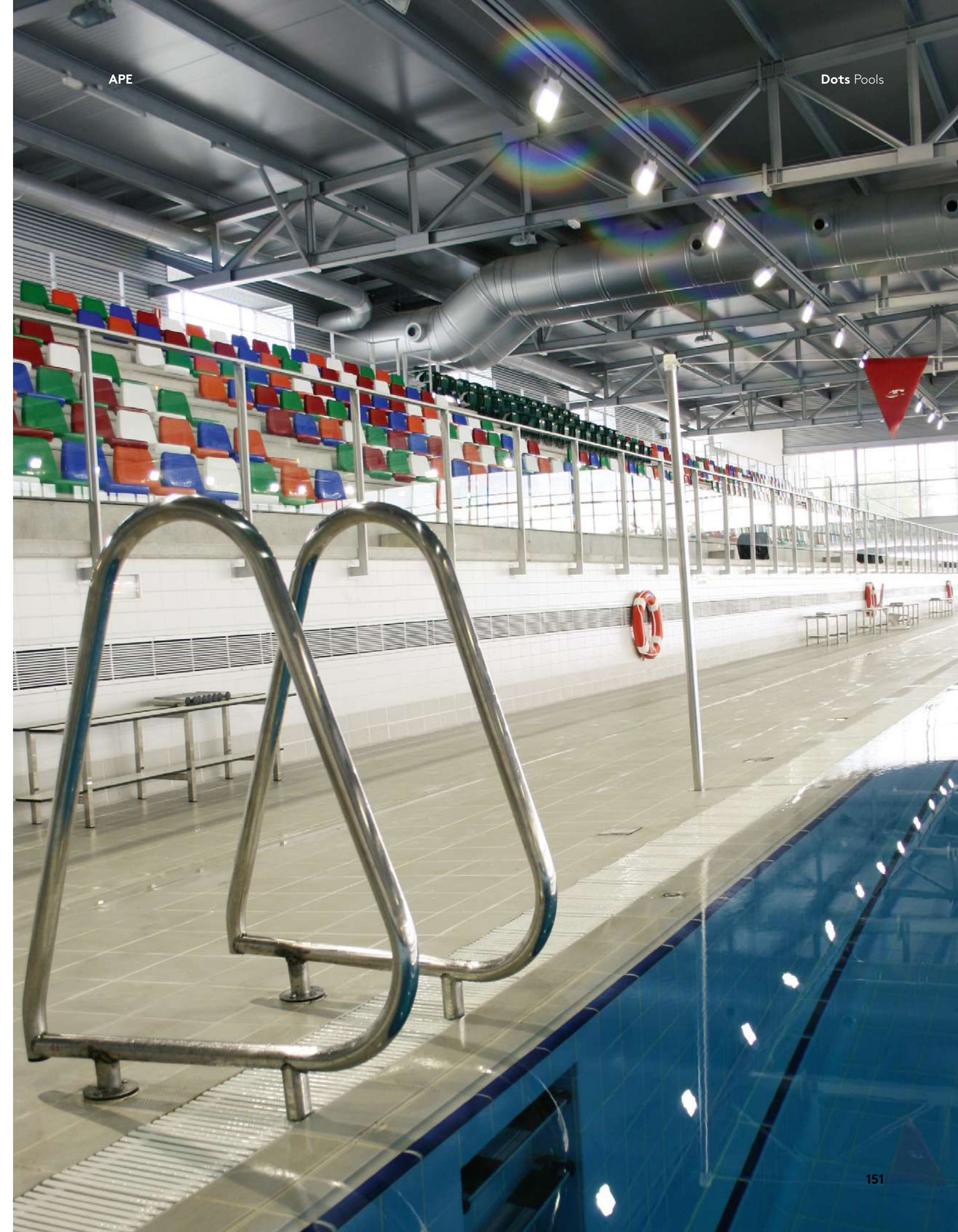

Grooved

Overflow pool.

The Finnish system with Grooved finish is the most used system for overflow pools in public facilities. Multi-use swimming pools, communal swimming pools and public swimming pools. This system offers a series of benefits:

Excellent visibility.

Attenuation of the waves in competition swimming pools.

Water film with a larger surface area than the tank.

Piscina desbordante.

El sistema finlandés con acabado Grooved es el sistema más utilizado para piscinas desbordantes en instalaciones de uso público. Piscinas polivalentes, piscinas comunitarias e instalaciones deportivas de uso público. Este sistema ofrece una serie de ventajas:

Excelente visibilidad.

Atenuación del oleaje en vasos deportivos de competición.

Lámina de agua con superficie mayor que el vaso.



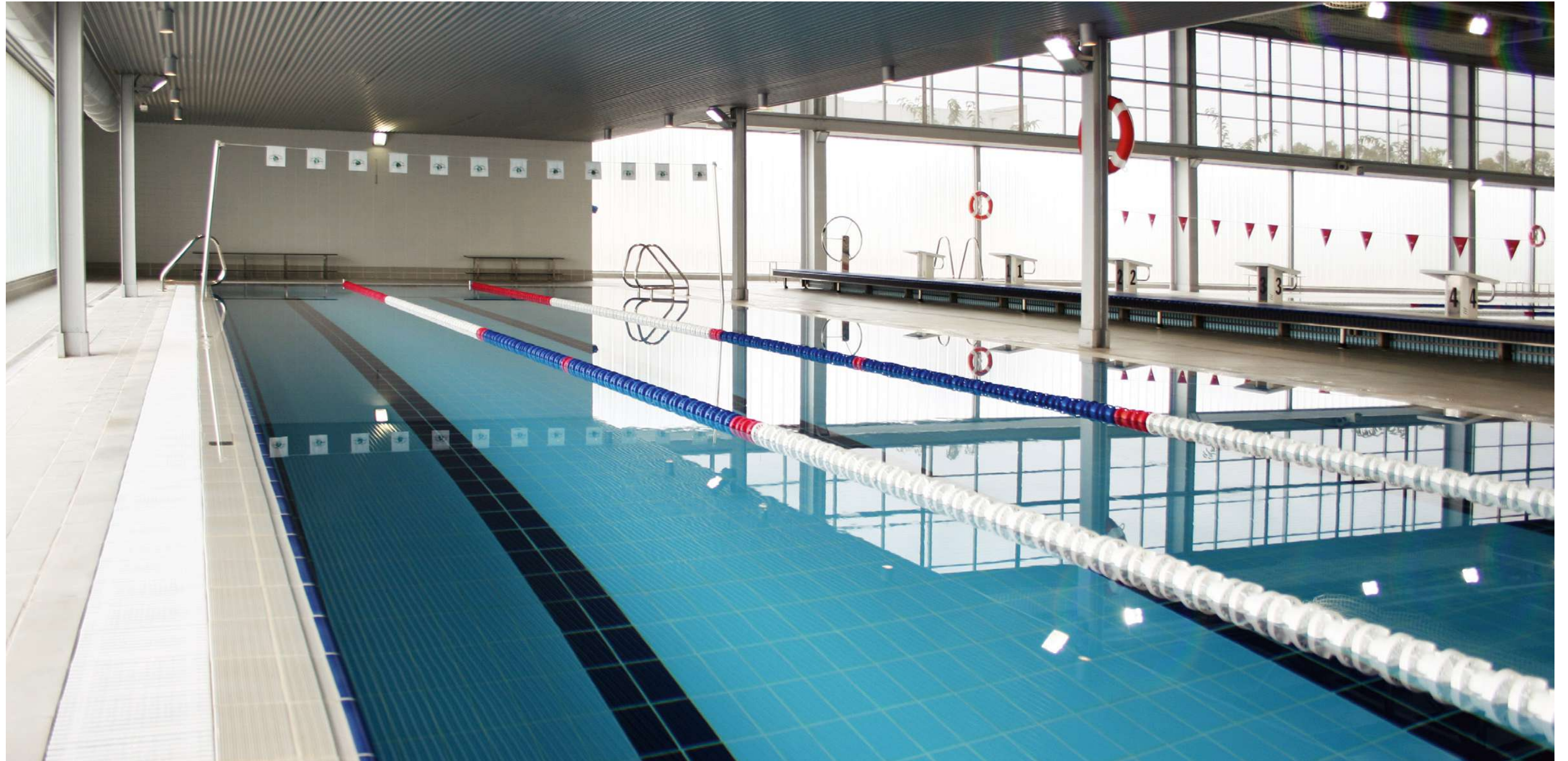

Dots

SPECIAL PIECES / PIEZAS ESPECIALES

OVERFLOW POOL / PISCINA DESBORDANTE

AVAILABLE COLORS / COLORES DISPONIBLES



420
BORDE DOTS
12X24,5X2,6 / 5"X10"X1"
(Azul) ● K92/P
(Beige) ● K92/P
(Blanco) ● K92/P
(Perla) ● K92/P

(Azul / Marino) ●● K85/P
(Beige / Marino) ●● K85/P
(Blanco / Marino) ●● K85/P
(Perla / Marino) ●● K85/P



423
BORDE ÁNGULO EXTERIOR DOTS
12X12X2,6 / 5"X5"X1,5" K60/P



422
BORDE ÁNGULO INTERIOR DOTS
12X12 / 5"X5" K60/P



410
SOPORTE REJILLA DOTS
13,5X24,5X3,5 / 5,3"X9,6"X1,4" K87/P
ONLY / SOLO: ● Azul, ● Perla, ● Beige y ● Blanco.



421
BORDE ESQUINA DOTS
17X17 / 7,7"X7,7" K60/P

OUTSIDE THE POOL / EXTERIOR DE LA PISCINA

AVAILABLE COLORS / COLORES DISPONIBLES

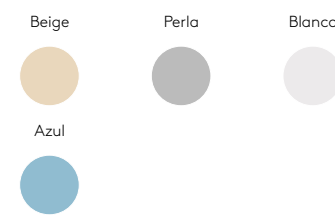

401
BASE DOTS
12X24,5X0,9 / 5"X10"X0,4" K44/P

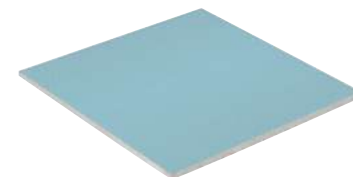

402
BASE DOTS
24,5X24,5X0,9 / 10"X10"X0,4" K19/P

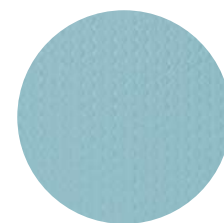

TEXTURE / TEXTURA



Grooved

SPECIAL PIECES / PIEZAS ESPECIALES

OVERFLOW POOL / PISCINA DESBORDANTE

AVAILABLE COLORS / COLORES DISPONIBLES

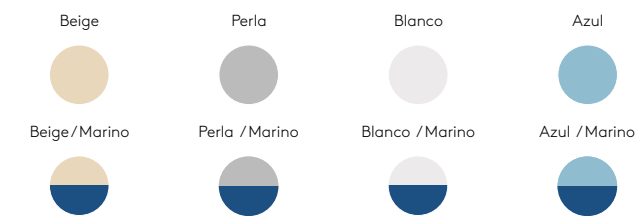

320
BORDE GROOVED
12X24,5X2,6 / 5"X10"X1"
(Azul) ● K92/P
(Beige) ● K92/P
(Blanco) ● K92/P
(Perla) ● K92/P

(Azul / Marino) ●● K85/P
(Beige / Marino) ●● K85/P
(Blanco / Marino) ●● K85/P
(Perla / Marino) ●● K85/P



323
BORDE ÁNGULO EXTERIOR GROOVED
12X12X2,6 / 5"X5"X1" K60/P



322
BORDE ÁNGULO INTERIOR GROOVED
12X12 / 5"X5" K60/P



310
SOPORTE REJILLA GROOVED
13,5X24,5X3,5 / 5,3"X9,6"X1,4" K87/P
ONLY / SOLO: ● Azul, ● Perla, ● Beige y ● Blanco.



321
BORDE ESQUINA GROOVED
17X17 / 7,7"X7,7" K60/P

OUTSIDE THE POOL / EXTERIOR DE LA PISCINA

AVAILABLE COLORS / COLORES DISPONIBLES

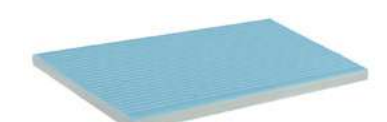
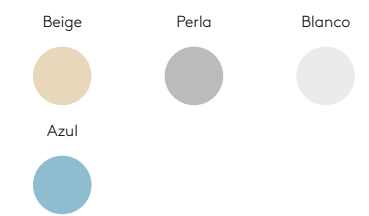

301
BASE GROOVED
12X24,5X0,9 / 5"X10"X0,4" K44/P

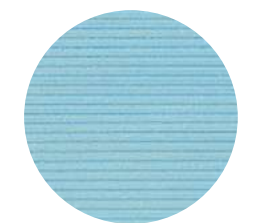

TEXTURE / TEXTURA



SPECIAL PIECES / PIEZAS ESPECIALES

INSIDE THE POOL / DENTRO DE LA PISCINA

AVAILABLE COLORS / COLORES DISPONIBLES



101
BASE LISA
12X24,5X0,9 / 5"X10"X0,4"
● Marino
K43/P
K31/P



201
BASE ANTI-SLIP SUAVE
12X24,5X0,9 / 5"X10"X0,4"
ONLY / SOLO: ● Azul y ● Blanco.
● Marino
K96/P
K97/P



SOLUTIONS FOR CORNERS AND ANGLES / SOLUCIONES PARA ESQUINAS Y ÁNGULOS

AVAILABLE COLORS / COLORES DISPONIBLES



186
ARISTA L
24,5 X 8 CM
10" X 3" - R6 CM
K24/P



183
ÁNGULO EXTERIOR ARISTA L
12 X 8 X 8 CM
5" X 3" X 3"
K15/P



185
MEDIA CAÑA L
24,5 X 8 CM
10" X 3" - R6 CM
K24/P



184
ÁNGULO INTERIOR ARISTA L
12 X 8 X 8 CM
5" X 3" X 3"
K15/P



187
UÑA L
8 X 8 CM
3" X 3" - R6 CM
K06/P



188
UÑA ARISTA L
8 X 8 CM
3" X 3" - R6 CM
K06/P

AVAILABLE COLORS / COLORES DISPONIBLES

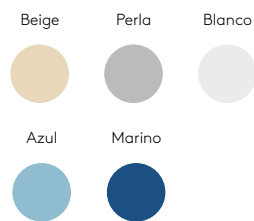

176
ARISTA
24,5 X 3 CM
10" X 1,2" - R3 CM
● Marino
K24/P
K29/P



175
MEDIA CAÑA
24,5 X 4 CM
10" X 1,5" - R3 CM
● Marino
K24/P
K29/P



177
UÑA
4 X 4 CM
1,5" X 1,5" - R3 CM
K06/P

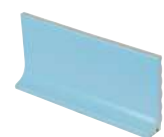

170
ZÓCALO SANITARIO CON ESCOCIA
ESMALTADO
12 X 24,5 X 3,5 CM
5" X 10" X 1,4"
● Marino
K18/P
K89/P



172
ÁNGULO EXTERIOR ARISTA
12 X 4,75
5" X 2" - R3 CM
● Marino
K48/P
K62/P



171
ÁNGULO INTERIOR ARISTA
12 X 4,75
5" X 2" - R3 CM
● Marino
K48/P
K62/P



178
UÑA ARISTA
3 X 3 CM
1,2" X 1,2" - R3 CM
K06/P

SPECIAL PIECES / PIEZAS ESPECIALES

Solutions in corners and level changes in:
Walking access stairs · Resting step · Walls · Internal/external benches · Built-in stairs.

Soluciones en esquinas y cambios de plano en:
Escaleras de acceso a pie · Descansillos · Muretes · Bancadas interiores y exteriores · Escaleras empotradas.

AVAILABLE COLORS / COLORES DISPONIBLES

smooth / liso

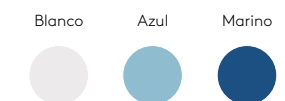

soft anti-slip / anti-slip suave

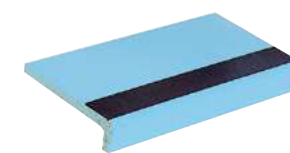

155
ANGULAR LISO
12X24,5X3 / 5"X10"X1,2"
● Azul, y ● Blanco.
● Marino
K35/P
K89/P

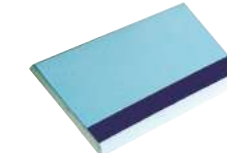

150
ROMO LISO
12X24,5X0,9 / 5"X10"X0,4"
● Azul, y ● Blanco.
● Marino
K90/P
K88/P

255
ANGULAR ANTI-SLIP
12X24,5X3 / 5"X10"X1,2"
● Azul, y ● Blanco.
● Marino,
● Azul/Marino,
● Blanco/Marino,
K35/P
K89/P
K89/P

250
ROMO ANTI-SLIP
12X24,5X0,9 / 5"X10"X0,4"
● Azul, y ● Blanco.
● Marino,
● Azul/Marino,
● Blanco/Marino,
K90/P
K88/P
K88/P

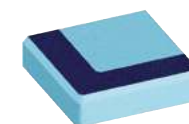

256
ESQUINA EXTERIOR ANGULAR ROMO
12X12X3 / 5"X5"X1,2"
K65/P



252
ESQUINA EXTERIOR ROMO
12X12X0,9 / 5"X5"X0,4"
K65/P

soft anti-slip / anti-slip suave

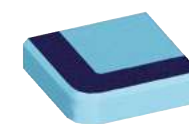

257
ESQUINA EXTERIOR
ANGULAR ARISTA
12X12X3 / 5"X5"X1,2"
K65/P



253
ESQUINA EXTERIOR
ROMO ARISTA
12X12X0,9 / 5"X5"X0,4"
K65/P

soft anti-slip / anti-slip suave

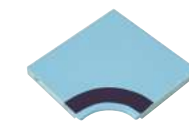

251
ESQUINA INTERIOR
17,5X17,5X0,9 / 6,7"X6,7"X0,4"
K65/P

soft anti-slip / anti-slip suave



SPECIAL PIECES / PIEZAS ESPECIALES

OVERFLOW CHANNEL / CANALETA

AVAILABLE COLORS / COLORES DISPONIBLES

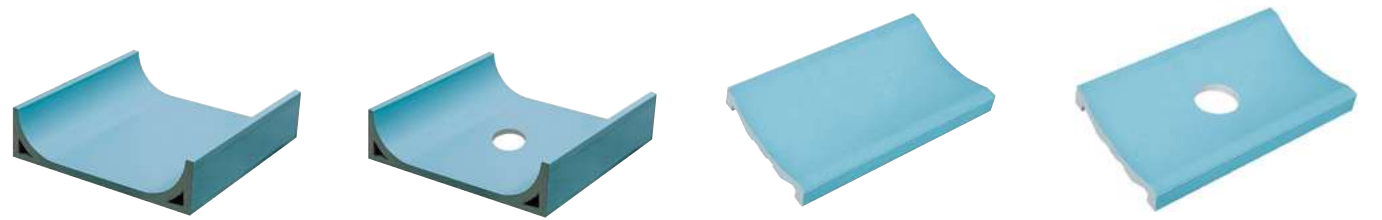

114
CANALETA
24,5 X 24,5 X 6,5 CM
10" X 10" X 2.6"
ONLY / SOLO:
● Azul y ● Blanco
K15/P

115
CANALETA SUMIDERO
24,5 X 24,5 X 6,5 CM - 10" X 10" X 2.6"
Ø 50-65 MM
ONLY / SOLO:
● Azul y ● Blanco
K75/P

112
CANALETA
15 X 24,5 X 3,5 CM
6" X 10" X 1.4"
K46/P

113
CANALETA SUMIDERO
15 X 24,5 X 6,5 CM - 6" X 10" X 1.4"
Ø 50-65 MM
K65/P

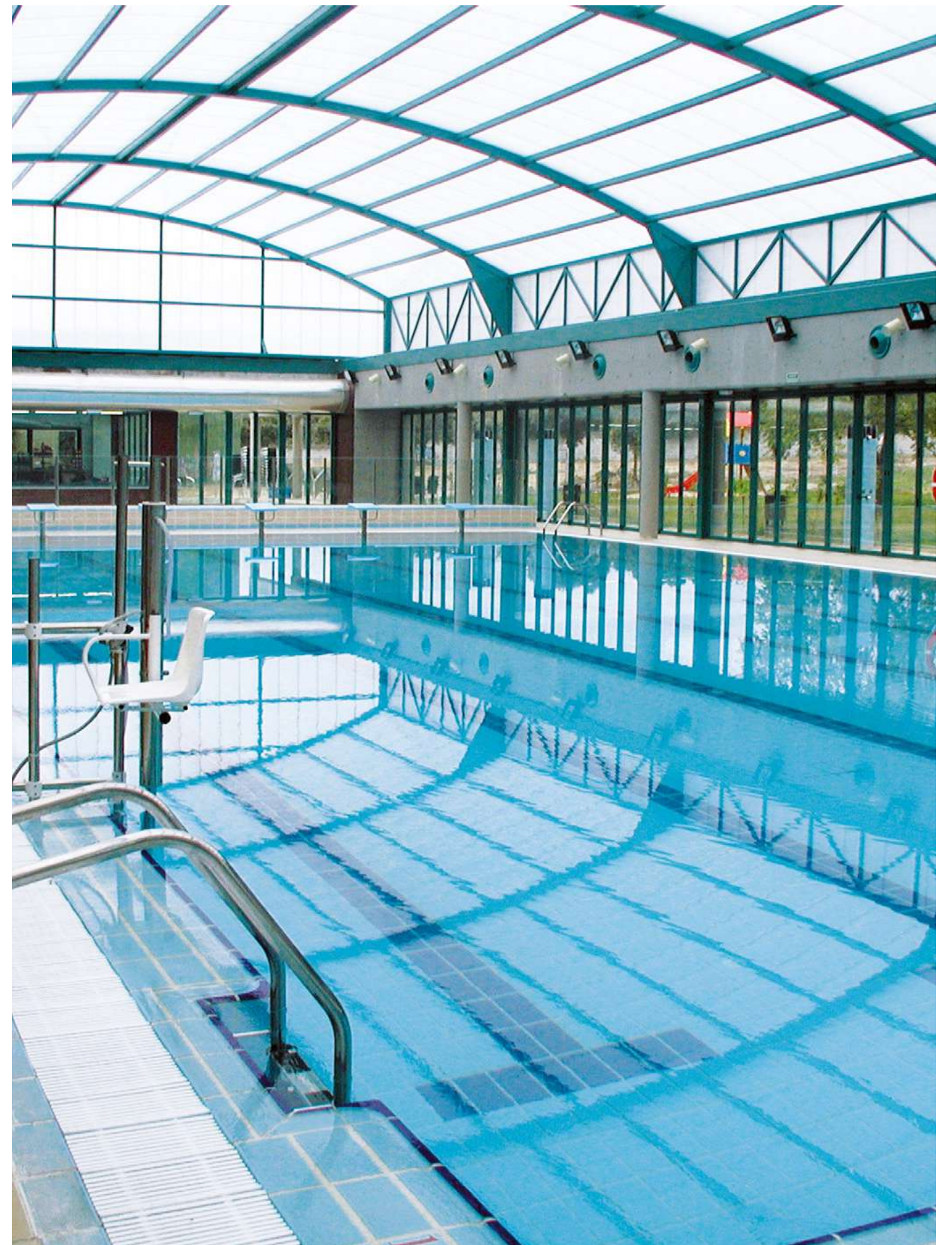



technical information

información técnica

CERAMIC GRATING / REJILLA CERAMICA

24,5x24,5/9,4"x9,4"
EXTRUSIONADO/EXTRUDED KLINKER

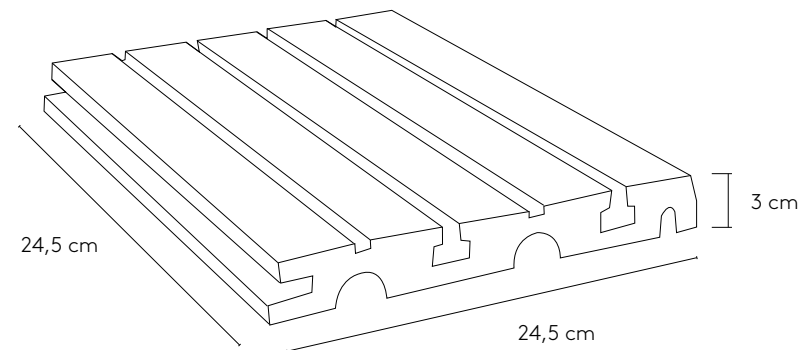

Exclusive ceramic grating for overflow pools.

Rejillas exclusivas para piscinas desbordantes.

The mesh strainer system for infinity pools allows the user to create overflow pools, giving a perfect solution to the most complex areas of multi-use swimming pools and public sport facilities and guaranteeing optimum safety in a homogeneous manner.

Some of the benefits of the system:

Omnidirectional anti-slipping. Homogeneous and safer compared with other grooved reliefs.

Easy laying and faster cleaning of the grout.

Easy and safe maintenance, thanks to the relief design.

Regarding the installation of the grids for the pool overflows, the most appropriate installation is to invert each piece 180° relative to the previous one. This way, the more superficial grooves in one piece pour the water into the deeper ones in the adjacent piece and improve drainage. (Image **A**)

It is also possible to lay all the pieces in the same direction, achieving a more aesthetic result. In this case it is essential to respect a separation between the pieces to allow the water to fall through the gutter that is generated in the intermediate space. (Image **B**)

El sistema de rejilla para piscinas desbordantes permite realizar piscinas de coronación desbordante, que da óptimas soluciones a las zonas más complejas de piscinas polivalentes e instalaciones deportivas de uso público, garantizando la máxima seguridad de manera homogénea.

Algunas ventajas de este sistema:

Antideslizamiento omnidireccional, homogéneo y más seguro, frente a otros relieves ranurados.

Fácil colocación y limpieza del rejuntado más rápida.

Mantenimiento rápido y seguro, debido al diseño del relieve.

En lo relativo la instalación de las rejillas para los rebosaderos de las piscinas, la colocación más adecuada es invertir cada pieza 180° respecto a la anterior. De esta forma los surcos más superficiales de una pieza vierten el agua a los más profundos de la pieza adyacente y mejoran el desagüe. (Imagen **A**)

También es posible colocar todas las piezas en el mismo sentido consiguiendo un resultado más estético. En este caso es imprescindible respetar una separación entre pieza y pieza para facilitar la caída del agua por la canaleta que se genera en el espacio intermedio. (Imagen **B**)

A.

B.



01. OXFORD C3 PURE 33X66,5/13"X26"
02. BORDE DESBORDANTE OXFORD PURE 28X66,5/11"X26"
03. REJILLA OXFORD PURE 24,5X24,5/9,4"X9,4"

OVERFLOW EDGE / BORDE DESBORDANTE

28x66,5/11"x26"
EXTRUSIONADO/EXTRUDED KLINKER

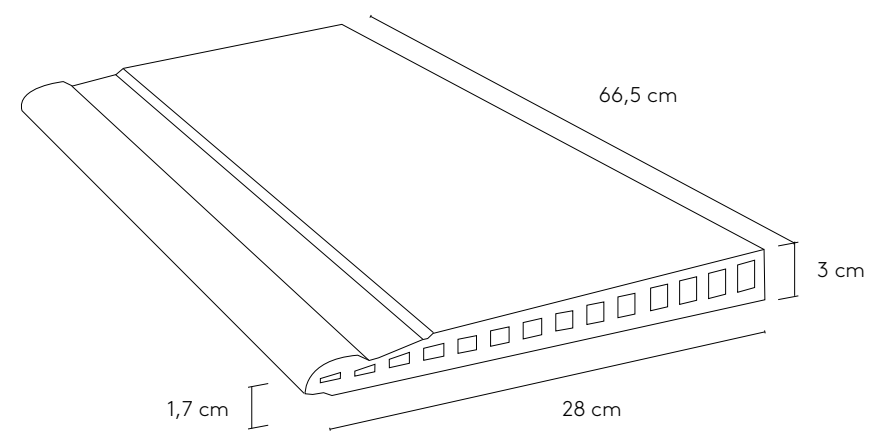

The overflow edge is a special extruded stoneware piece with a light tilt. It is designed so that the tiling arrives to the end of the swimming pool.

The overflow edge with a mesh strainer guarantees excellent results, not only from a practical perspective, draining the water, but also from an aesthetic perspective, creating an increase of the perception of the swimming pool size.

El borde desbordante es una pieza especial de gres extrusionado que tiene una ligera inclinación y que está diseñada para que el solado llegue hasta el final de la piscina.

El borde desbordante con rejilla garantiza excelentes resultados, tanto desde un punto de vista práctico, permitiendo la recogida y drenaje del agua, como desde un punto de vista estético creando un aumento en la percepción del tamaño de la piscina.

MAINTENANCE

Easy cleaning

With a minimum effort APE's swimming pools are perfectly maintained. In addition, porcelain stoneware is not susceptible to microbial formations, so you can swim peacefully.

MANTENIMIENTO

Limpieza fácil

Con un mínimo esfuerzo las piscinas de APE se mantienen perfectas. Además el gres porcelánico no es susceptible de formaciones microbianas, así que su tranquilidad será total.

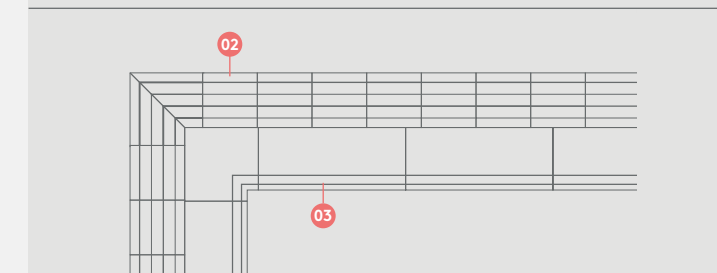
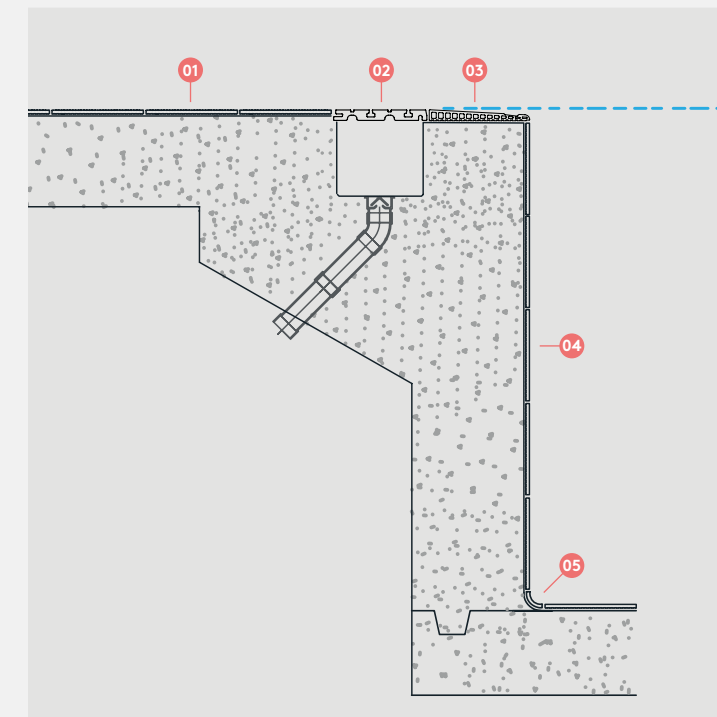

- | | | |
|----|-------------------|---------------|
| 01 | BASE | BASE |
| 02 | REJILLA | GRATING |
| 03 | BORDE DESBORDANTE | OVERFLOW EDGE |
| 04 | BASE LISA | FLAT BASE |
| 05 | MEDIA CAÑA | COVE |



STAIR TREAD STRAIGHT / PELDAÑO RECTO

33x120x3 / 13"x48"x1"
EXTRUSIONADO/EXTRUDED KLINKER

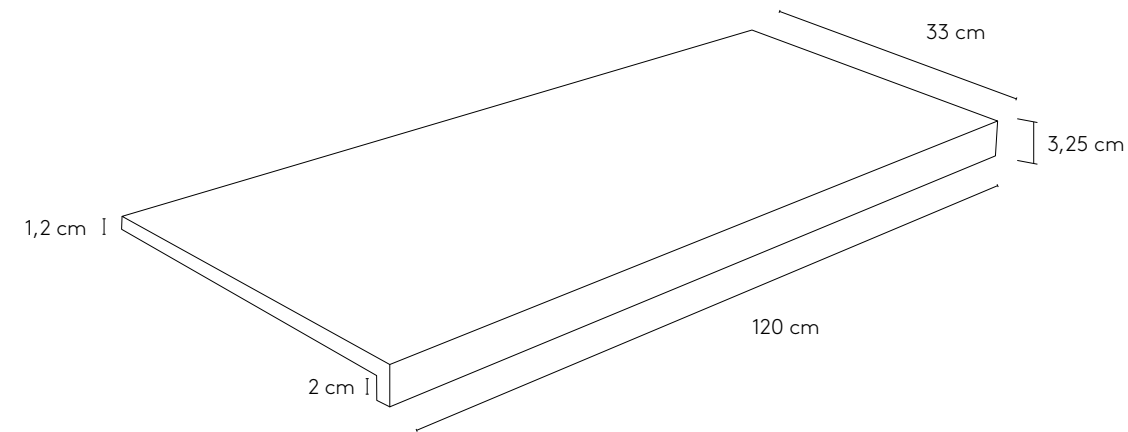

Our collections include straight steps for a more linear, minimalist aesthetic finish. Moreover, the steps are also used for the swimming pool stairs, so that the result becomes homogeneous.

One of the advantages of this system is that it is more efficient regarding cleaning and energy consumption. In addition, it needs less space in relation to an infinity pool, as the latter needs a compensation tank or a channeling able to store between 5% and 10% of the total of the volume of the swimming pool for the replenishment of water.

Nuestras colecciones incluyen peldaños rectos que permiten un acabado estético más lineal y minimalista. Además los peldaños se usan también en las escaleras interiores de la piscina, por lo que se homogeneiza el resultado.

Entre las ventajas de este sistema es que es más eficiente en lo relativo a limpieza y consumo energético. Además precisa menor espacio respecto a una piscina desbordante, ya que esta precisa un depósito de compensación o espacios de canalización suficientes para almacenar entre un 5 y un 10% del total del volumen de la piscina para la reposición de agua.

SECURITY

No slips

APE's anti-slip technology provides maximum safety in the tank, on the edge and on the perimeter of the swimming pool. It is visually pleasing and easy-to-clean.

SEGURIDAD

Sin resbalones

Los antideslizantes de APE aportan la máxima seguridad, tanto en la zona de playa como en el borde y el vaso de la piscina. Son agradables y fáciles de limpiar.

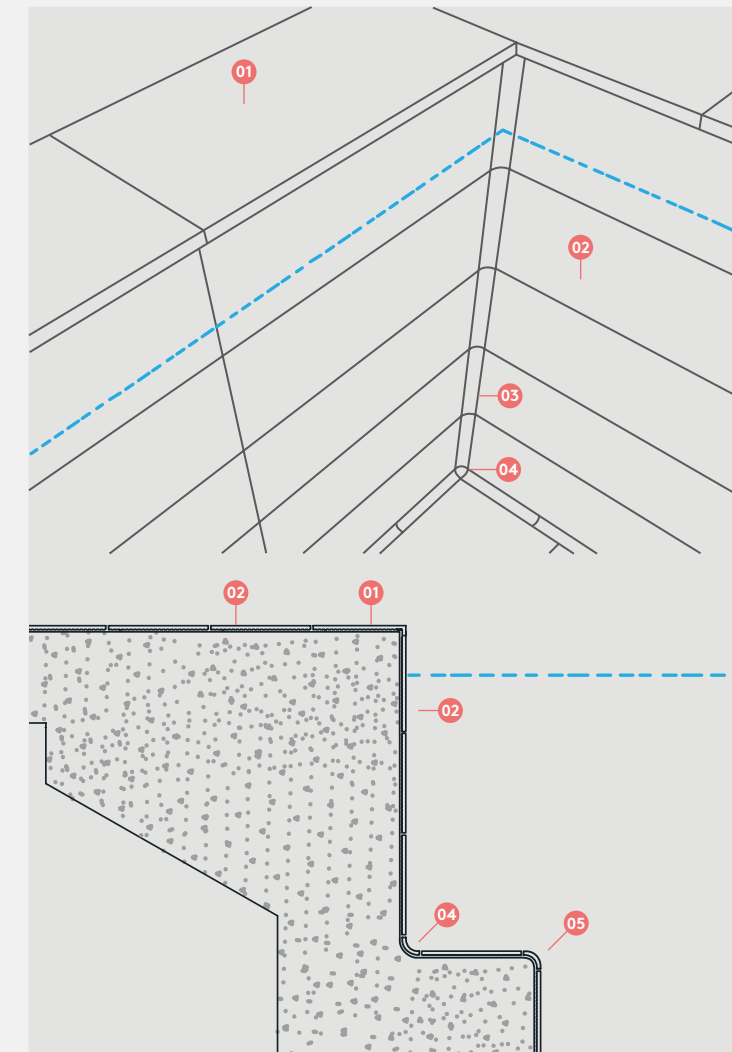

01	PELDAÑO RECTO	STAIR TREAD STRAIGHT
02	BASE	BASE
03	MEDIA CAÑA	COVE
04	UÑA	COVE CORNER TRIM
05	ARISTA	TRIM



TRADITIONAL POOL / PISCINA TRADICIONAL

28x66,5x4,5/11"x26"x2"
EXTRUSIONADO/EXTRUDED KLINKER

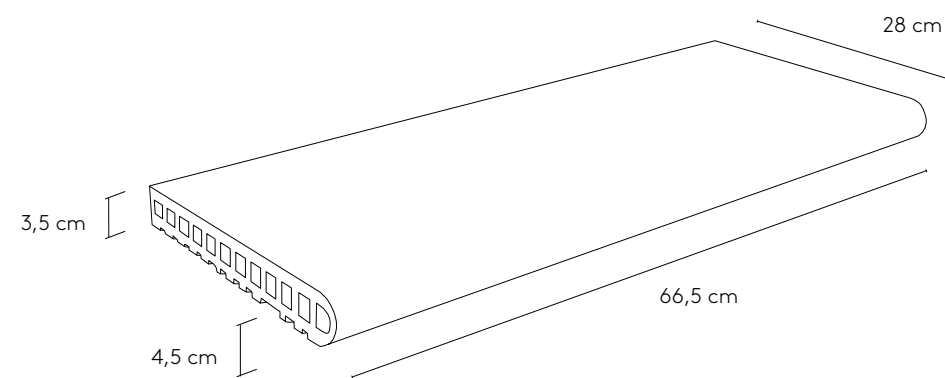

Traditional pools can be topped with rounded swimming pool edges.

A classic piece with the attributes of extrusion.

Las piscinas tradicionales pueden ser coronadas con bordes de piscina redondeadas.

Una pieza clásica con las propiedades del extrusionado.

IT LASTS FOREVER

The perfect swimming pool.

Every summer your swimming pool will be working as well as the first day. Since a swimming pool is a dream, at APE we want to help you make it come true.

ES PARA SIEMPRE

La piscina perfecta.

Cada verano tu piscina estará funcionando tan bien como el primer día. Porque una piscina es un sueño y en APE queremos ayudarte a hacerlo realidad.

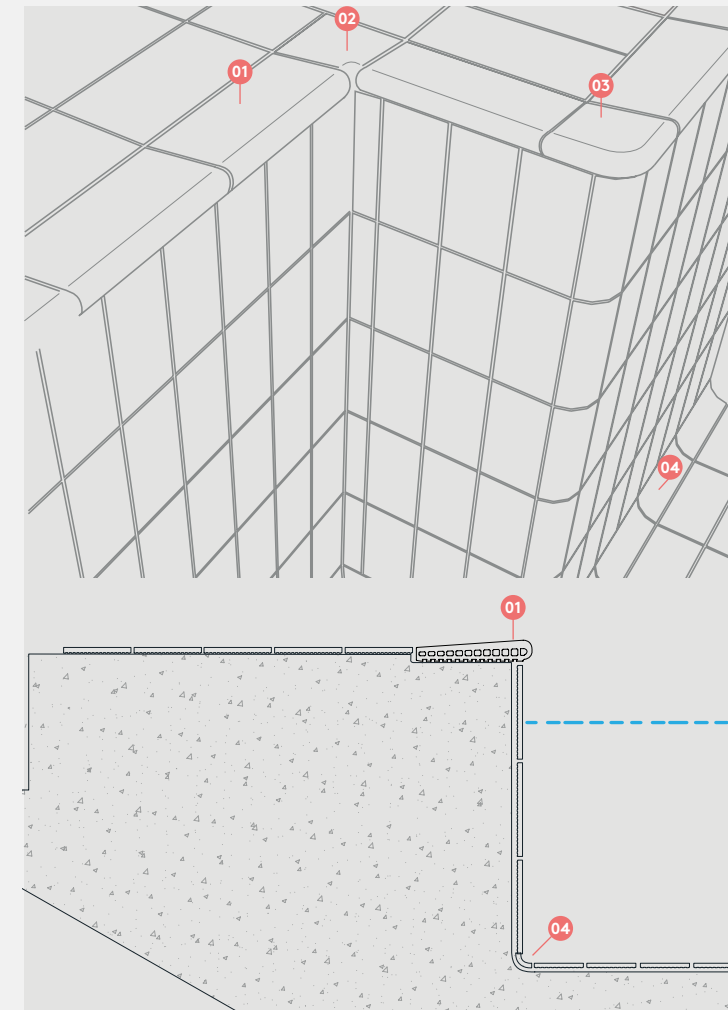

- | | | |
|----|-------------------------|----------------------|
| 01 | BORDE PISCINA | POOL BORDER EDGE |
| 02 | ÁNGULO INTERIOR PISCINA | POOL INTERIOR CORNER |
| 03 | ÁNGULO EXTERIOR PISCINA | POOL EXTERIOR ANGLE |
| 04 | MEDIA CAÑA | COVE |

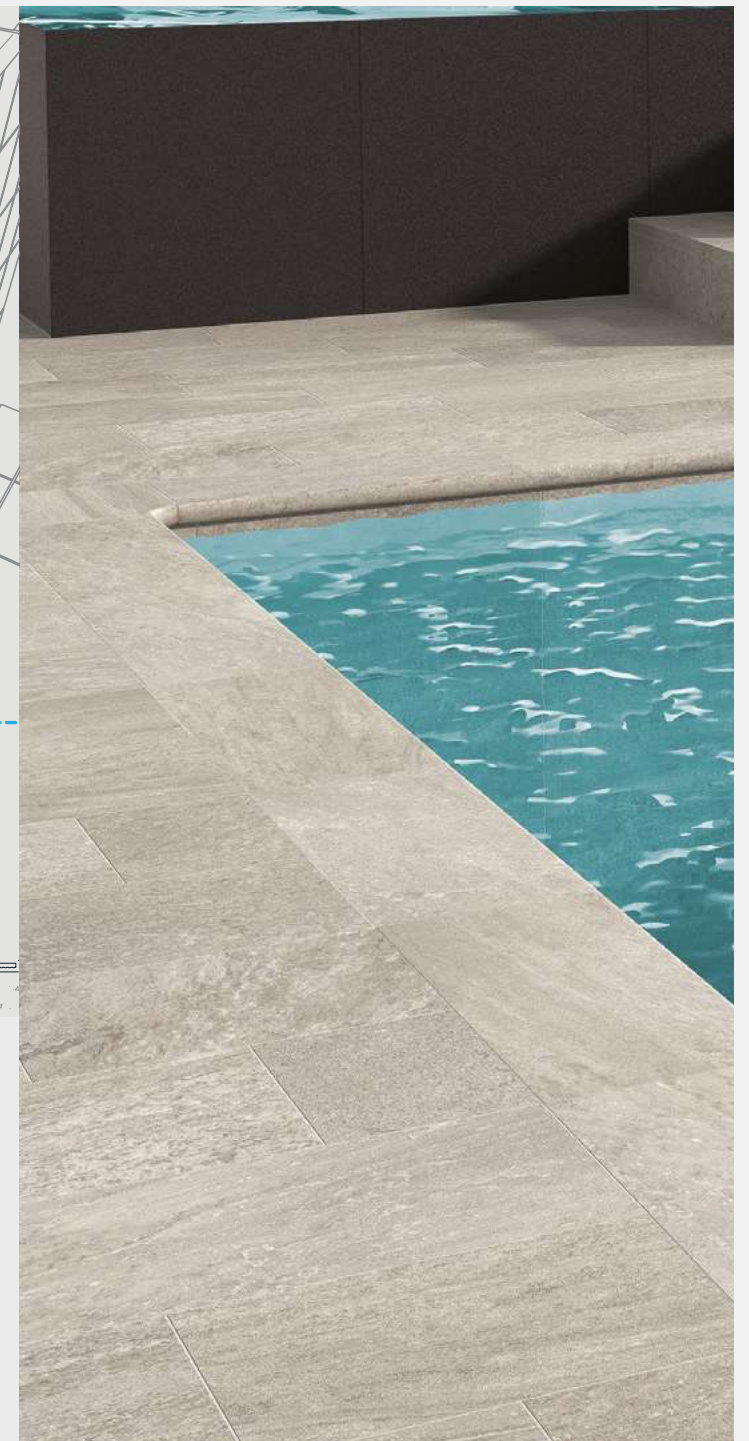

TRADITIONAL POOL / PISCINA TRADICIONAL

45x75x3 / 18"x30"x1"
EXTRUSIONADO/EXTRUDED KLINKER

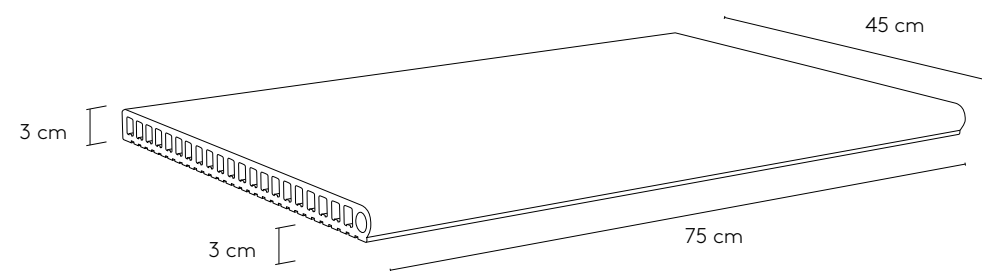

The skimmer system can be installed with a rounded edge or a straight step.

The skimmer system is the classic system in which the water surface is 20cm below the edge of the swimming pool. It is equipped with a less complex filtration system, so the economic investment is lower.

El sistema skimmer puede instalarse con un borde redondeado o con un peldaño recto.

El sistema de skimmer es el sistema clásico en el que la superficie del agua está a unos 20 cm por debajo del borde de la piscina, equipado con un sistema de filtrado menos complejo, por lo que reduce la inversión económica en esta instalación.

RESISTANCE

The material that never deteriorates.

It does not alter its properties nor change its color after exposure to sunlight. It is resistant to contact with water and chemical products for filtration. It does not break or crack.

RESISTENCIA

El material que nunca se estropea.

No se altera ni cambia de color con la radiación del sol. No le afecta el contacto con el agua ni los productos químicos para la depuración. No se rompe ni se agrieta.

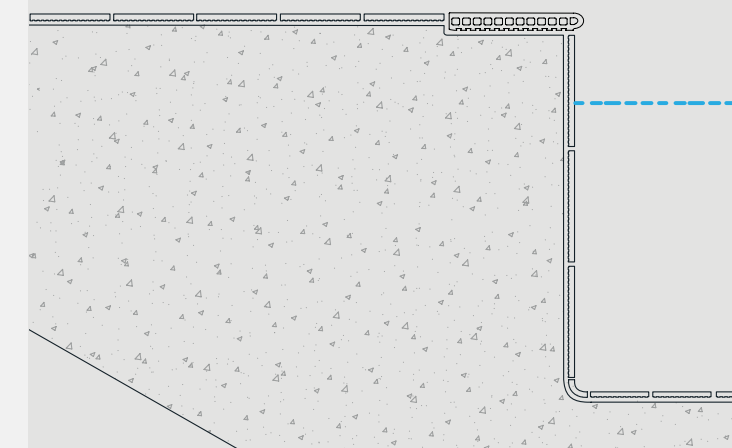
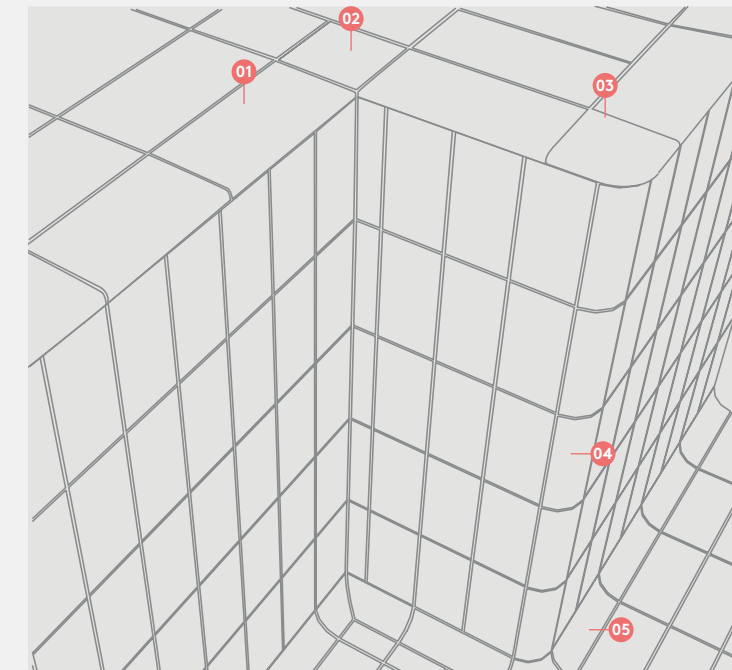

- | | | |
|----|-------------------------|----------------------|
| 01 | BORDE PISCINA | POOL BORDER EDGE |
| 02 | ÁNGULO INTERIOR PISCINA | POOL INTERIOR CORNER |
| 03 | ÁNGULO EXTERIOR PISCINA | POOL EXTERIOR ANGLE |
| 04 | ARISTA | TRIM |
| 05 | MEDIA CAÑA | COVE |



PUBLIC POOLS EDGE/BORDE PISCINAS PUBLICAS

EXTRUSIONADO/EXTRUDED KLINKER

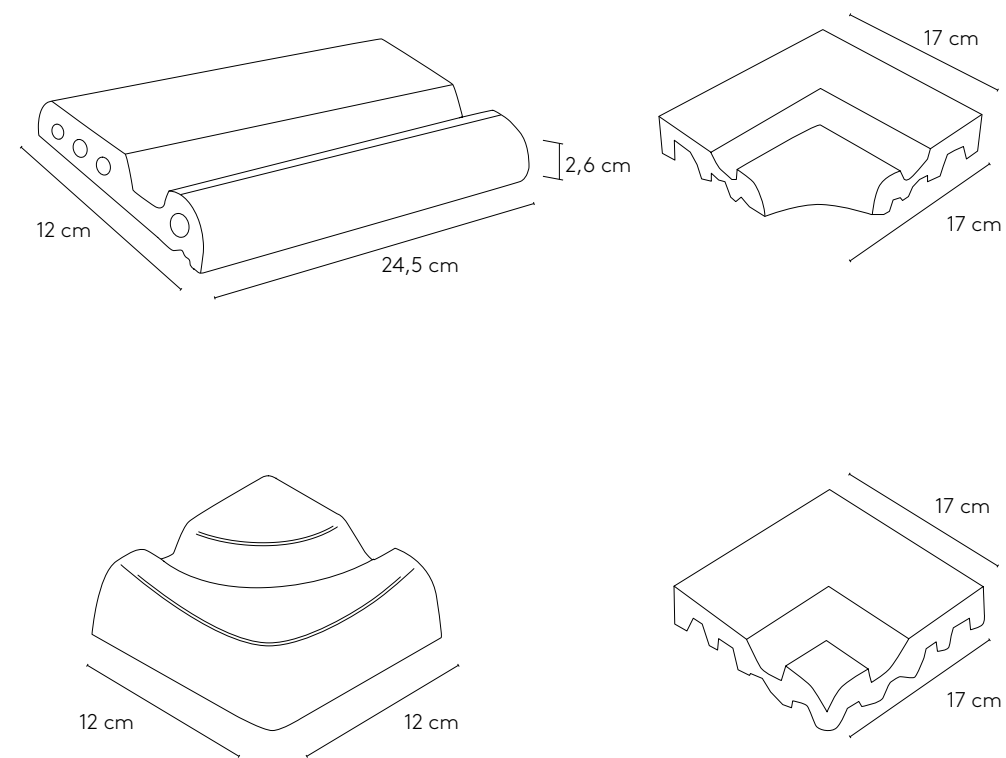

APE dedicates a product line for public swimming pools with infinity edge and stands out for its hygienic and aesthetic advantages.

Infinity pools are those where the water overflows the perimeter and is gathered by a groove that runs around the swimming pool. This channel filters the water and keeps it always clean.

APE dedica una línea de producto para piscinas de uso público que habitualmente optan por sus ventajas higiénicas y estéticas por un sistema desbordante.

Las piscinas desbordantes son aquellas en las que el agua se desborda por el perímetro de la piscina y es recogida en una canaleta que bordea el vaso. En este canal se filtra el agua consiguiendo mantenerla siempre limpia

SECURITY

No slips

APE's anti-slipping systems allow for maximum safety in the tank, on the edge and around the perimeter of the swimming pool. They are visually pleasing and easy-to-clean.

SEGURIDAD

Sin resbalones

Los antideslizantes de APE aportan la máxima seguridad, tanto en la zona de playa como en el borde y el vaso de la piscina. Son agradables y fáciles de limpiar.

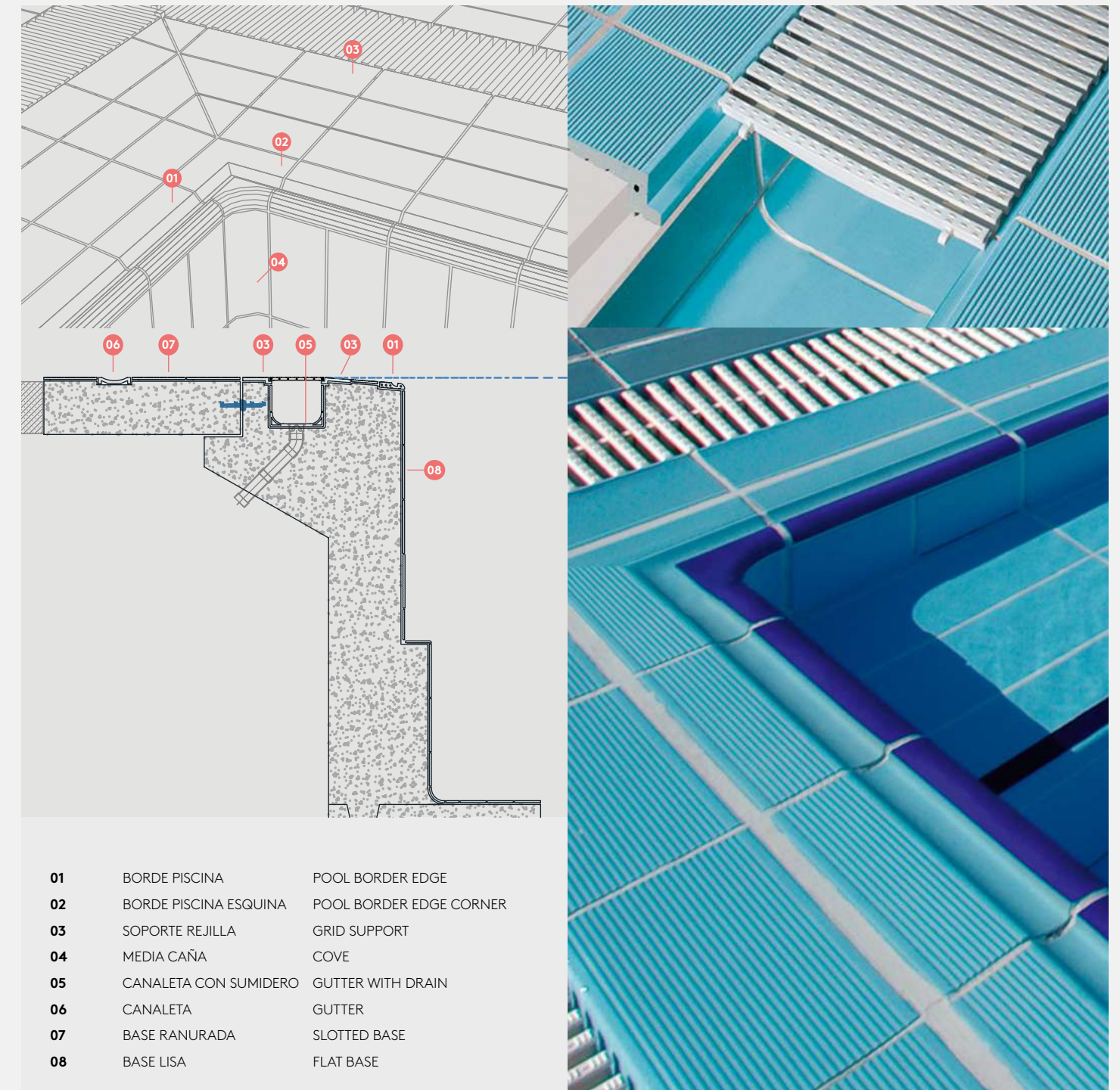

- | | | |
|----|-----------------------|-------------------------|
| 01 | BORDE PISCINA | POOL BORDER EDGE |
| 02 | BORDE PISCINA ESQUINA | POOL BORDER EDGE CORNER |
| 03 | SOPORTE REJILLA | GRID SUPPORT |
| 04 | MEDIA CAÑA | COVE |
| 05 | CANALETA CON SUMIDERO | GUTTER WITH DRAIN |
| 06 | CANALETA | GUTTER |
| 07 | BASE RANURADA | SLOTTED BASE |
| 08 | BASE LISA | FLAT BASE |

SPECIAL PIECES PUBLIC SWIMMING POOLS / PIEZAS ESPECIALES PISCINAS PÚBLICAS

Solutions in corners and level changes in:
Walking access stairs · Resting step · Walls · Internal/external benches · Built-in stairs.

Soluciones en esquinas y cambios de plano en:
Escaleras de acceso a pie · Descansillos · Muretes · Bancadas interiores y exteriores · Escaleras empotradas.

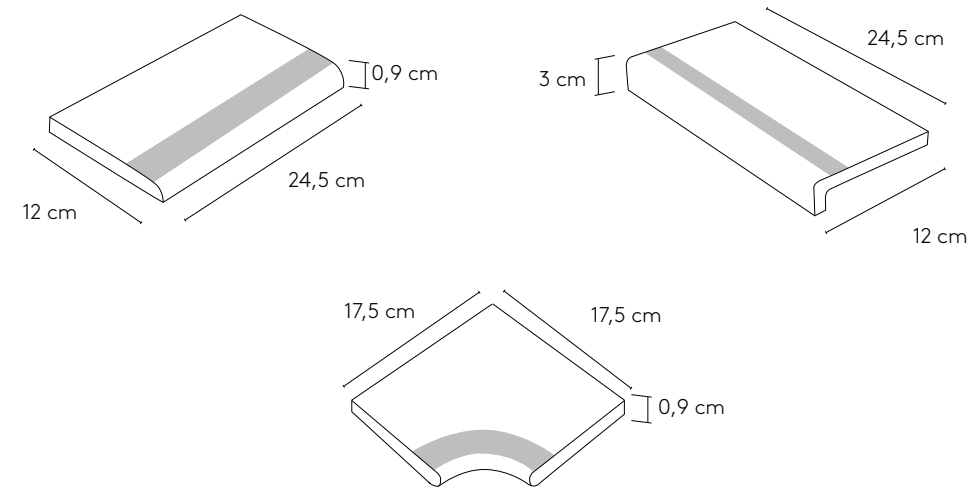

The tank is the structure that contains the water. The interior covering is used to protect and prevent leaks. This covering has become a very important decorative element.

Our office consists of a series of pieces that allow us to cover the tank and give solutions for corners and change of planes.

El vaso de la piscina es la estructura que contiene el agua. El recubrimiento interior sirve para proteger y evitar las fugas de agua pero también se ha convertido en un elemento decorativo de gran importancia.

En nuestra oferta contamos con una serie de piezas que nos permiten revestir el vaso de la piscina y dar soluciones para aristas o cambios de plano

Many special pieces help to coat the swimming pool's tank and guarantee that it functions properly. In order to obtain an interesting aesthetic finish, these pieces maintain continuity with the swimming pool's crowning and tiling.

Son muchas las piezas especiales que ayudan a revestir el vaso de la piscina y aseguran su buen funcionamiento. Para conseguir un acabado estético interesante estas mantienen continuidad con los sistemas de coronación y el solado de la piscina.

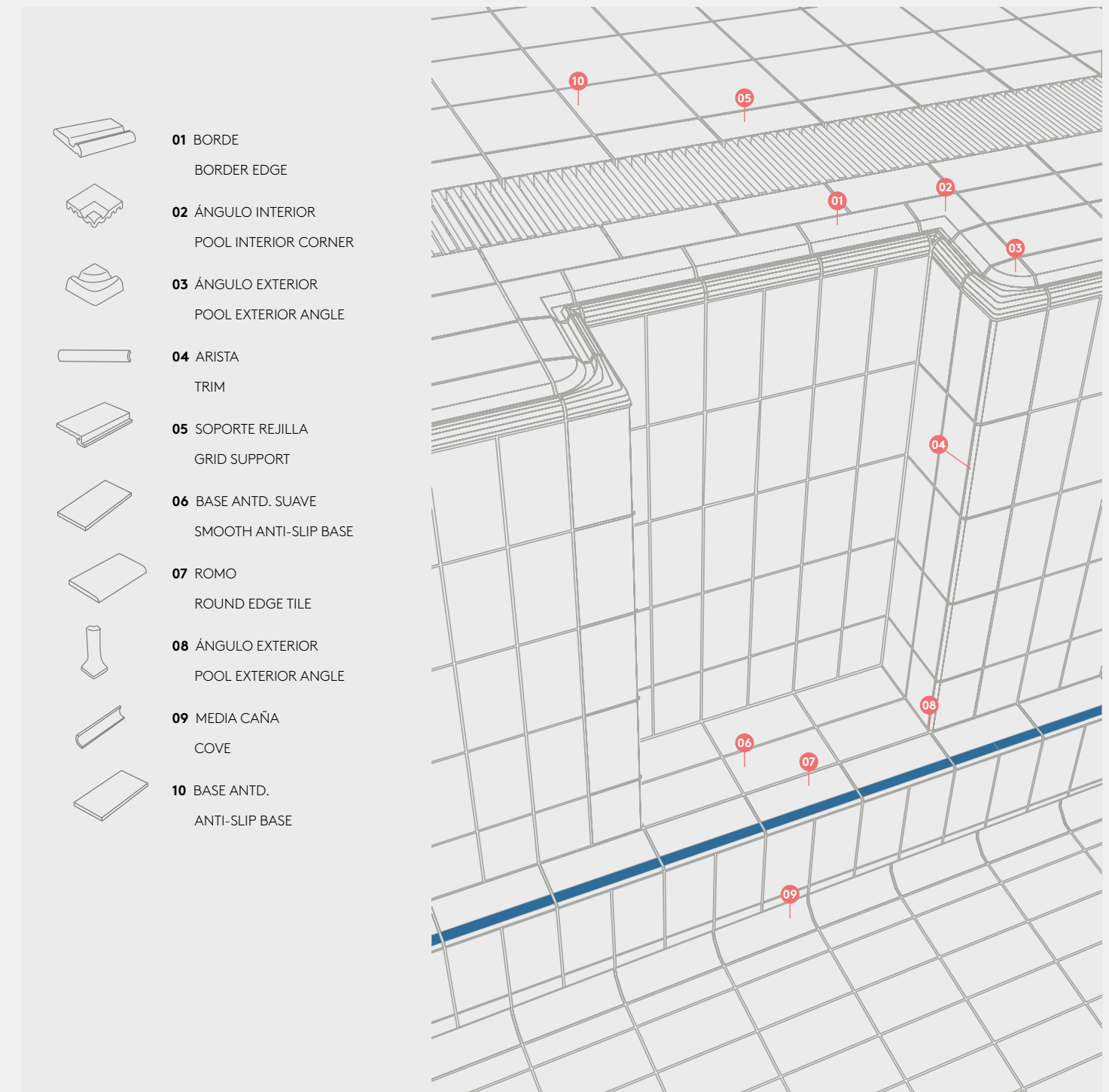

**SWIMMING POOLS CONSTRUCTION /
CONSTRUCCIÓN DE PISCINAS Y ESPACIOS HÍDRICOS**

Pool coverings, sport facilities and all other ludic and wellness wet areas are exposed to several different demands due to their function, the use conditions and also the setting place.

Basic requirements for a swimming pool coating are: ergonomics, resistance, waterproofing and security.

Extruded klinker ceramic is extremely resistant and offers an overall solution to all requirements needed in such installations. Shape, color and texture variety and special pieces wide range that gives functional solutions to technical design demand in order to obtain long-lasting coating with high quality finished.

Ergonomic shapes, non-pore surfaces, non slip finishes where it is necessary, bright glazings with chemical resistance to deal with water conditioning products, the disinfection and cleaning process.

Easy maintenance is equal to hygienic and healthy spaces.

Using extruded klinker ceramics is a secure and profitable investment.

Los recubrimientos de las piscinas, instalaciones deportivas y la totalidad de los espacios hídricos de uso lúdico y terapéutico, están expuestas a altas y variadas solicitudes debido a su función y también del entorno donde se ubican.

Las demandas básicas exigibles a estos recubrimientos son: ergonomía, resistencia, impermeabilidad y seguridad.

El gres extrusionado es extremadamente resistente y ofrece soluciones a todos los requisitos que se plantean en instalaciones de este tipo. Variedad de formas, colores, texturas y una amplia gama de piezas especiales que dan respuesta funcional a las demandas de diseño de los técnicos proyectistas, para obtener recubrimientos duraderos, estéticos y con alta calidad de acabados.

Formas ergonómicas, superficies sin poros, antideslizantes donde sea necesario, esmaltados luminosos y químicamente resistentes para soportar los productos de acondicionamiento del agua y los procesos de limpieza y desinfección.

Mantenimiento fácil equivale a instalación higiénica y saludable.

Utilizar gres extrusionado es una inversión segura y rentable.

**BAREFOOT WALKING AREAS FLOORING /
PAVIMENTACIÓN DE PLAYAS Y ESPACIOS ANEXOS**

Barefoot walking areas like those surrounding swimming pools, solariums, changing rooms and others undergo several situations: wet conditions, water from pools, dirt and dust in outdoor areas. These actions and others (impacts, abrasion, frost action) are decisive to tiles choosing criteria.

The selected tile must be no slip, with mechanical, chemical and frost resistance, very low surface porosity, and easy to clean.

APE recommends anti-slip C Class (DIN 51097) for usually wet floors in swimming pools, sport facilities and similar spaces.

Zonas interiores húmedas, vestuarios, baños, aseos y duchas.	
Superficies con pendiente menor que el 6%	Clase 2
Superficies con pendiente igual o mayor que el 6% y escaleras	Clase 3

Zonas exteriores. Piscinas (1).	
(1) Zonas previstas para usuarios descalzos y fondos de vasos de profundidad que no exceda a 1,5 m	Clase 3

Las playas y espacios anexos a una piscina, como vestuarios, servicios, solarios y otros son transitados con pie descalzo y frecuentemente con agua, humedad, ensuciamiento por uso, polvo y contaminación en caso de playas exteriores. Estas solicitudes junto a otras (golpes, abrasiones, acción de heladas) son determinantes a la hora de seleccionar una baldosa para pavimentar estos espacios.

La baldosa elegida debe ser antideslizante, con resistencia mecánica, química y a la helada, con mínima porosidad superficial y fácilmente limpiable.

La aprobación en España del Código Técnico de la Edificación (C.T.E.) supone un endurecimiento de los requisitos de antideslizamiento en las piscinas en general e instalaciones deportivas de uso público a fin de garantizar la seguridad del usuario frente al riesgo de caídas. El Documento Básico SU1 (Seguridad de Utilización) establece la obligatoriedad de pavimentos con Resistencia al Deslizamiento (Rd) en función de su localización y su Clase exigible, concretamente es: *

APE recomienda en playas, vestuarios, servicios, locales técnicos, coronación de piscinas y otras superficies antideslizantes, utilizar baldosas y piezas especiales con textura superficial calificadas como Clase 3 (C.T.E. ensayo péndulo UNE-ENV 12633) en proyectos ejecutados dentro del territorio español. Para proyectos ejecutados en otros países recomendamos utilizar baldosas y piezas especiales calificadas como Clase C (ensayo pie descalzo, plano inclinado DIN 51097).

**INSTALLATION RECOMMENDATIONS /
RECOMENDACIONES DE COLOCACIÓN**

Must be considerate substrate type and conditions of use. Surface to be covered shall be cleaned to remove bitumen, soil, dust, curing compounds, form, oil, sealants or grease. In spas, therapy pools, thermal baths, leisure centers and talasotherapy (sea water pools), high resistance grouts (chemical and abrasion) is very recommended.

BEFORE INSTALLATION. PREVIOUS TASKS

- Check tile system, different special pieces, colors and textures, and submit to Management.
- Check the substrate condition, geometry, surface quality, cracks and moisture.
- Leveling and waterproofing the substrate. Pass waterproofing test before tile installation.
- Check sizes pool, and levels (overflow and pool edge levels).
- Movement joints placement, according to Management.
- Stock-pit organization: place the tiles at different workplaces.
- Detailed layout plan: checking sizes, modularity and singular points.
- Make an installation planning, is very recommended.

TILES INSTALLATION

- Mark the reference lines, making a control grid.
- Mark the central axe and its perpendicular lines every 2 m. making a grid pattern.
- Use mark lanes as guidelines, in the short walls and bottom of the pool.
- Place a row of tiles along both lanes. Distribute tiles between lanes, align them following the grid.
- Put the cut pieces in the bottom of the pool.
- The joint between pieces will be 5 mm. to respect modularity and the correspondence of joints between different sizes and/or specials pieces.

THIN BED INSTALLATION

Over leveling substrate, adhesives are applied with a notched trowel. Mortar thickness is between 5 mm-10 mm. The substrate should be clean, sound, dry, plumb and true (3mm/3m). Use leveling coat mortar if need be. Over concrete walls all cracks must be repaired prior the tiling. Pool edge and back high profiled pieces, should be back-buttered to help achieve maximum coverage.

**RECOMMENDED PRODUCTS
LEVELING COAT MORTAR:**

Latex admix gives the mortar flexibility and bonding strength.
WATERPROOFING:
Direct bond rubber reinforced membranes.
Direct bond reinforced waterproof mortars.
SETTING:
Adhesive C2 type (EN 12004) better C2 TE type.
Use square notch trowel.
GROUTING:
CG2 type (EN 13888).
RG for stain, abrasion and high chemical resistance.
Use hard rubber trowel.
Fill the expansion joints with a flexible sealants: silicone or poliurethane.

Hay que considerar el tipo de soporte y las condiciones de uso de la instalación. La superficie a revestir debe estar limpia de asfaltos, aceites, grasas, polvo, aditivos del hormigón. En balnearios, piscinas terapéuticas, termas, hidromasajes - spas, y talasoterapia (piscinas con agua de mar) se recomienda utilizar juntas de alta resistencia química y a la abrasión.

TAREAS PREVIAS A LA COLOCACIÓN

- Comprobar y clasificar el material suministrado a obra, diferentes baldosas y piezas especiales, colores y texturas, sometiendo el sistema de recubrimiento a la Dirección Facultativa.
- Comprobar las condiciones del soporte, geometría, aplomado de aristas y rincones, calidad superficial, retracción y humedad residual.
- Nivelar el soporte si es necesario. Impermeabilizar y verificar con Prueba de Estanqueidad.
- Comprobar dimensiones del vaso y los niveles de desborde y coronación.
- Situar las juntas de movimiento y partición de acuerdo con la D.F.
- Organización de acopios a pie de tajo.
- Replanteo detallado: medidas, modularidad y piezas en puntos singulares.
- Planificación de ejecución.

INSTALACIÓN DE LA CERÁMICA

- Marcar líneas de referencia cada 2 m. formando una retícula de control.
- Marcar el eje de simetría y marcar las líneas de calles en las paredes cortas.
- Utilizar la marcación de calles como referencia, colocando baldosas enteras entre ellas, siguiendo la retícula.
- En caso necesario situar las piezas cortadas en el fondo del vaso.
- La junta entre las piezas será de 5 mm. para respetar la modularidad de las series y la correspondencia de juntas entre los diferentes formatos y/o piezas especiales.

COLOCACIÓN POR EL SISTEMA DE CAPA DELGADA

- Sobre soportes regulares y nivelados, usando adhesivos mediante llana dentada.
- El espesor de mortero adhesivo es 5-10 mm.
- El soporte debe ser sano, limpio, seco, plano (3 mm de desnivel, como máximo, en 3 m.) y aplomado.
- Usar un mortero de nivelación si es necesario.
- Sobre soportes de hormigón hay reparar las grietas antes de la colocación.
- La piezas de coronación y las de cola de milano acentuadas (Groove, apoyo rejilla, ranuradas, etc) se colocarán con doble encolado para asegurar un total macizado.

**PRODUCTOS RECOMENDADOS
PARA NIVELAR Y REGULARIZAR LAS SUPERFICIES:**

Usar morteros con Aditivo Látex
PARA IMPERMEABILIZAR:
Membranas bituminosas reforzadas con fibras que se aplican directamente al soporte.
Morteros impermeabilizantes reforzados con fibras que se aplican directamente al soporte.
PARA INSTALAR LAS BALDOSAS:
Adhesivo Tipo C2 (según norma EN 12004) preferentemente C2TE.
Usar llana dentada.
PARA REJUNTAR:
Mortero de Juntas Tipo CG2 (según EN 13888).
Tipo RG para resistencia a las Manchas y alta Resistencia Química.
Usar llana de goma.
LAS JUNTAS DE EXPANSIÓN deben rellenarse con Selladores Flexibles de Silicona o Poliuretánicos.

EXTRUSION VALUES / EL VALOR DE LA EXTRUSIÓN

The raw materials selected and the careful production process with the most advanced technologies and our human team work, ensure that final product have a exceptional technical characteristics.

With this process three-dimensional geometries can be obtained in the pieces, impossible to obtain with the traditional pressing process.

Las materias primas seleccionadas y el cuidado proceso de producción con las tecnologías más avanzadas y la labor de nuestro equipo humano, hacen que el producto obtenido posea unas características técnicas excepcionales.

Con este proceso se pueden obtener geometrías tridimensionales en las piezas, imposibles de conseguir con el proceso de prensado tradicional.



EXTRUSION PROCESS / PROCESO DE EXTRUSIÓN

Extrusion process is a forming technique for the manufacture of ceramic products. Basically this process consists in forcing the passage, through the application of a pressure, of the paste with a plastic consistency through a matrix. The manufacture of tiles by the extrusion process entails four main phases: kneaded, shaping, drying and firing.

The kneading consists in the mixing with water of the raw materials previously prepared and ground. This provides an easily extrudable paste.

- In the shaping stage, the plastic mass using vacuum pressure is kneaded and pushed through the nozzle to make tiles. This process is widely used to make special tiles pieces like steps or swimming pool border tiles, ... etc.

- Once the tiles have been shaped, hot air is used to remove the moisture content.

- Afterwards they are fired to high temperatures, to obtain a perfect vitrification.

With this process, the tiles can be recycled completely and up to 45% recycled materials are accepted in their standard process.

La extrusión es una técnica de conformado para la fabricación de productos cerámicos. Básicamente el proceso de extrusión consiste en forzar el paso, mediante la aplicación de presión, de la pasta con consistencia plástica a través de una matriz. La fabricación de baldosas mediante el proceso de extrusión consta de cuatro fases principales: amasado, conformado, secado y cocción.

- El amasado consiste en el mezclado con agua de las materias primas previamente preparadas y molidas. Con esto se consigue una pasta fácilmente moldeable por extrusión.

- En el conformado se realiza introduciendo la masa plástica en la extrusora, y con presión de vacío es amasada y empujada a través de la boquilla para obtener las piezas finales. Con este proceso se pueden obtener piezas especiales como peldaños o bordes piscinas, etc...

- Después las piezas ya moldeadas son sometidas a aire caliente para eliminar el contenido de humedad.

- Posteriormente son cocidas a altas temperaturas, obteniendo una perfecta vitrificación de las mismas.

Con este proceso los materiales pueden ser reciclados en su totalidad y admiten hasta un 45% de materiales reciclados en su proceso estándar.

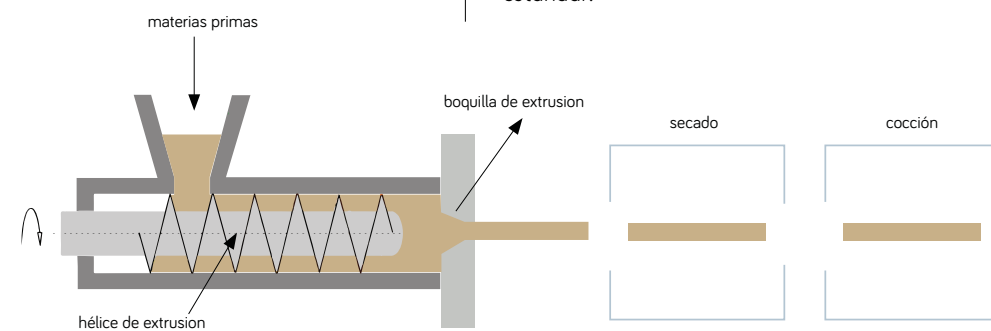

PROCESO DE EXTRUSIÓN - EXTRUSION PROCESS

**TECHNICAL DATA / CARACTERÍSTICAS TÉCNICAS
EXTRUDED KLINKER / GRES EXTRUIDO**

White body extruded klinker stoneware with a low water absorption, according to EN 14411, group Alb, glazed.

Gres extruido de pasta blanca de baja absorción de agua, según UNE-EN 14411, grupo Alb esmaltado.

NORMA/TEST	DESCRIPCIÓN / DESCRIPTION	REQUISITOS / STANDARDS	PISCINAS / SERIES
ISO 10545-2	Dimensiones / Sizes Longitud y anchura / Length and width Espesor / Thickness Rectitud de los lados / Straightness of sides Ortogonalidad / Rectangularity Planaridad / Surface Flatness	± 1,5% ± 10% ± 0,6% ± 1,0 % ± 1,5 %	Cumple ampliamente la norma / Amply meets the standard
ISO 10545-3	Absorción de agua / Water absorption	≤ 3 %	≤ 1,5 %
ISO 10545-4	Fuerza de rotura / Breaking strength	≥ 1.100 N	≥ 1.300 N
ISO 10545-4	Resistencia a la flexión / Modulus of rupture	≥ 23 N/mm2	≥ 40 N/mm2
ISO 10545-9	Resistencia al choque térmico / Resistance to thermal shock	exigida / required	garantizado / guaranteed
ISO 10545-11	Resistencia al cuarteo / Crazeing resistance	exigida / required	garantizado / guaranteed
ISO 10545-12	Resistencia a la helada / Frost resistance	exigida / required	garantizado / guaranteed
ISO 10545-13	Resistencia a los agentes químicos / Chemical resistance	exigida / required	A/LA/HA
ISO 10545-14	Resistencia a las manchas / Stain resistance	exigida / required	clase 5 / class 5
UNE-ENV 12633:2003	Resistencia al deslizamiento (péndulo) / Slip Resistance (pendulum)	exigida (CTE) / required (CTE)	CLASE 3 / CLASS 3
DIN 51097	Ángulo Crítico Deslizamiento (pie descalzo) / Anti-slip resistance (barefoot)	-	GRUPO C / C GROUP
DIN 51130	Ángulo Crítico Deslizamiento (rampa) / Anti-slip resistance (ramp)	-	R10-R12

TECHNICAL DATA/ CARACTERÍSTICAS TÉCNICAS
PORCELAIN TILE/ PORCELÁNICO











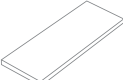
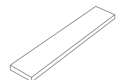

	Testing method/ Método de prueba	Measurement unit/ Unidad de medida	Values/ Valores Típicos Medios	Established limits/ Valores límite previstos	Reference standard/ Norma de referencia
Water absorption in % Absorción de agua en %	ISO 10545-3	%	≤ 0,5	≤ 0,5 Maximum single value 0,6% Valor único máximo 0,6%	UNI EN 14411-G
Dimensions Dimensiones	ISO 10545-2	mm %	Complies with the standards. Conforme con las normas.	N ≥ 15	UNI EN 14411-G
Length and width Longitud y anchura				± 2 % max ± 5 mm	
Length and width Longitud y anchura				± 0,6 % ± 2 mm	
Length and width Longitud y anchura				± 0,6 % ± 2 mm	
Thickness Espesor				± 5 % ± 0,5 mm	
Edge straightness Rectitud de los cantos				± 0,5 % ± 1,5 mm	
Orthogonality Ortogonalidad				± 0,5 % ± 2 mm	
Flatness Planeidad				x ± 0,5 % ± 2 mm	
Appearance Aspecto				≥ 95%	
Bending strength Resistencia a la flexión	ISO 10545-4				UNI EN 14411-G
Modulus of rupture Módulo de rotura		N/mm ²	≥ 28	28 Minimum single value 21 Valor único mínimo 21	UNI EN 14411-G
Breaking strenght Esfuerzo de rotura		N	≥ 1300	≥ 1300	UNI EN 14411-G

TECHNICAL DATA/ CARACTERÍSTICAS TÉCNICAS
PORCELAIN TILE/ PORCELÁNICO

	Testing method/ Método de prueba	Measurement unit/ Unidad de medida	Values/ Valores Típicos Medios	Established limits/ Valores límite previstos	Reference standard/ Norma de referencia
Resistance deep abrasion Resistencia a la abrasión profunda	ISO 10545-6	mm ³	120-150	≤ 1 75	UNI EN 14411-G
Frost resistance Resistencia a la helada	ISO 10545-12		Complies with the standards Conforme con las normas	Test passed in accordance with the en iso 10545-1 standard Prueba superada de conformidad con la norma EN ISO 10545-1	UNI EN 14411-G
Thermal shock resistance Resistencia al choque térmico	ISO 10545-9		Complies with the standards Conforme con las normas	Test passed in accordance with the en iso 10545-1 standard Prueba superada de conformidad con la norma EN ISO 10545-1	UNI EN 14411-G
Linear thermal expansion coefficient Coeficiente de dilatación térmica lineal	ISO 10545-8	x10 ⁻⁶ /°C	≤ 9	Test method available Método de control disponible	UNI EN 14411-G
Stain resistance Resistencia a las manchas	ISO 10545-14		Clase 5 Class 5 Categoría 5	Value declared Valor declarado	UNI EN 14411-G
Resistance to chemicals for household use and swimming pool salts Resistencia a los productos químicos para uso doméstico y sales para piscina	ISO 10545-13		A	B Minimum B Mínimo	UNI EN 14411-G
			LA - LB HA - HB	Value declared Valor declarado	UNI EN 14411-G
Color resistance to light exposure Resistencia de los colores a la exposición de la luz	DIN 51094		Complies with the standards Conforme con las normas	No sample must show noticeable color modifications. Ninguna muestra ha de presentar alteraciones apreciables de color.	
Resistenza allo scivolamento Skid resistance Resistencia al deslizamiento	RAMP METHOD		R9	from R9 to R13 de R9 a R13	DIN 51130 BGR 181 1
			R10		
			R11		
			R12V4		





PACKING LIST/LISTA DE EMBALAJE
EXTRUDED KLINKER/GRES EXTRUIDO

PRIVATE POOL/PISCINA PRIVADA

	SIZE/FORMATO	Piezas/caja Pieces/box	Kg/caja Kg/box	Cajas/pallet Boxes/pallet	Kg/pallet Kg/pallet
	Base 33x33 cm	9 9 pcs/m2	22,18	56	1242
	Base 33x66,5 cm	5 4,5 pcs/m2	25,38	40	1015
	Base 16,25x66,5 cm	10 9 pcs/m2	25,30	40	1012
	Base 32,5x32,5 cm	7 9 pcs/m2	24,10	63	1518
	Base 32,5x32,5x1,2 cm	9 9 pcs/m2	21,33	63	1344
	Borde desbordante 28x66,5 cm	2	13,60	72	980
	Rejilla 24,5x24,5 cm	6 4 pcs/ml	15,78	57	900
	Media caña 33x4 cm - r 3 cm	52 3 pcs/ml	13	64	832
	Arista 33x3x cm - r3 cm	70 3 pcs/ml	13	64	832
	Uña 4x4 cm	4	0,4	72	30
	Uña arista 3x3 cm	4	0,4	72	30
	Peldaño recto 33x60x3 cm	2	11,70	20	234
	Peldaño recto 33x120x3 cm	2	23,64	11	260
	Peldaño recto 33x33x3 cm	4	12,25	56	686,04

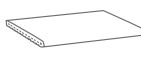
PACKING LIST/LISTA DE EMBALAJE
EXTRUDED KLINKER/GRES EXTRUIDO

PRIVATE POOL/PISCINA PRIVADA

	SIZE/FORMATO	Piezas/caja Pieces/box	Kg/caja Kg/box	Cajas/pallet Boxes/pallet	Kg/pallet Kg/pallet
	Borde Skimmer 45x75 cm	2 1,33 pcs/ml	31,40	30	942
	Ángulo Interior Piscina 33x33 cm	1	4,80	92	441
	Ángulo Exterior Piscina 28x28 cm	1	4,00	92	368
	Borde Piscina 28x66,5 cm	1 1,5 pcs/ml	10,75	72	774



















PACKING LIST / LISTA DE EMBALAJE
EXTRUDED KLINKER / GRES EXTRUIDO

PUBLIC POOL / PISCINA PÚBLICA

	Size / Formato	Pzs/Caja Pieces/Box	Kg/Caja Kg/Box	Cajas/Pallet Boxes/Pallet	Kg/Pallet Kg/Pallet
	Borde Dots 12x24,5x2,6 cm	12 4 pcs/ml	13,80	63	870
	Borde Esquina Dots 17x17 cm	4	6,00	-	-
	Ángulo Interior Dots 12x12 cm	4	3,70	-	-
	Ángulo Exterior Dots 12x12 cm	4	2,80	-	-
	Soporte Rejilla Dots 13,5x24,5x3,5 cm	8 4 pcs/ml	9,5	96	912
	Canaleta 15x24,5x3,5 cm	8 4 pcs/ml	11,12	69	768
	Canaleta Sumidero 15x24,5x3,5 cm	8 4 pcs/ml	11,00	69	768
	Base Dots 12x24,5 cm	35 32 pcs/m ²	19,25	77	1.482
	Base Dots 24,5x24,5 cm	16 16 pcs/m ²	19,79	69	1.365
	Borde Grooved 12x24,5x2,6 cm	12 4 pcs/ml	13,80	63	870
	Borde Esquina Grooved 17x17 cm	4	6,00	-	-
	Ángulo Interior Grooved 12x12 cm	4	3,70	-	-
	Ángulo Exterior Grooved 12x12 cm	4	2,80	-	-
	Soporte Rejilla Ranurada 13,5x24,5x3,5 cm	8 4 pcs/ml	9,5	96	912
	Canaleta 24,5x24,5x6,5 cm	4 4 pcs/ml	10,28	36	370
	Canaleta Sumidero 24,5x24,5x6,5 cm Ø 50 - 65 mm	4 4 pcs/ml	10,28	36	370
	Base Ranurada 12x24,5 cm	35 32 pcs/m ²	19,25	77	1.482
	Base Antideslizante suave 12x24,5 cm	35 32 pcs/m ²	19,25	77	1.482
	Romo 17,0x17,05 cm	35 4 pcs/ml	19,25	77	1.482
	Esquina Interior 12x12 cm	4	3,20	-	-

PACKING LIST / LISTA DE EMBALAJE
EXTRUDED KLINKER / GRES EXTRUIDO

PUBLIC POOL / PISCINA PÚBLICA

	Size / Formato	Pzs/Caja Pieces/Box	Kg/Caja Kg/Box	Cajas/Pallet Boxes/Pallet	Kg/Pallet Kg/Pallet
	Esquina Exterior Romo 12x12 cm	4	3,92	-	-
	Esquina Ext. Romo Arista 12x12 cm	4	3,92	-	-
	Angular 12x24,5x3 cm	16 4 pcs/ml	13,92	52	677
	Esquina Ext. Angular Romo 12x12x3 cm	4	1,98	-	-
	Esquina Ext. Angular Arista 12x12x3 cm	4	2,00	-	-
	Base 12x24,5 cm	35 32 pcs/m ²	19,25	77	1.482
	Zócalo sanitario con escocia esmaltado 12x24,5x3,5 cm	16 4 pcs/ml	12,10	57	684
	Ángulo Interior 12x4,75 cm r=3 cm	15	0,55	-	-
	Ángulo Exterior 12x4,75x4,75 cm r= 3 cm	10	0,82	-	-
	Media caña 24,5x4 cm r= 3 cm	50	7,60	114	870
	Arista 24,5x3 cm	64 4 pcs/ml	8,45	114	970
	Uña 4x4 cm r= 3 cm	4	0,40	72	30
	Uña arista 3x3 cm	4	0,40	72	30
	Media caña 24,5x8 cm	20 4 pcs/ml	7,60	128	958
	Arista 24,5x8 cm	22 4 pcs/ml	7,00	114	800
	Ángulo exterior Arista 12x8x8 cm	4	1,30	-	-
	Ángulo interior Arista 12x8x8 cm	4	1,30	-	-
	Uña 8x8 cm	4	0,60	-	-
	Uña arista 8x8 cm	4	0,60	-	-

PACKING LIST / LISTA DE EMBALAJE
PORCELÁNICO/PORCELAIN TILES

	Size / Formato	Pzs/Caja Tiles/Box	M ² /Caja Sqm/Box	Kg/Caja Kg/Box	Cajas/Pallet Boxes/Pallet	M ² /Pallet Sqm/Pallet	Kg/Pallet Kg/Pallet
4.Stones	60X120	2	1,44	32,19	36	51,84	1.159
	40X120	1	0,48	22,38	48	23,04	1.074
	30X120	4	1,44	33,92	36	51,84	1.221
	20X120	4	0,96	22,93	40	38,40	917
Alabama	90X90	2	1,62	37,34	24	38,88	896
	20X120	6	1,44	32,61	44	63,36	1.435
Burlington	75X75	2	1,13	26,16	45	50,63	1.177
	60X120	2	1,44	33,60	30	43,20	1.008
	60X60	3	1,08	24,35	40	43,20	974
Cross	30X60	6	1,08	24,75	40	43,20	990
	60X120	2	1,44	34,78	32	46,08	1.113
	60X60	4	1,44	32,83	30	43,20	984
Deep Blue	30X60	6	1,08	13,05	48	51,84	626
	15X15	44	1,00	17,12	64	64,00	1.095
Himalayas	30X60	6	1,08	18,68	40	43,20	747
	15X15	22	0,50	9,28	120	59,40	1.113
Illinois	15X15	22	0,50	9,17	120	59,40	1.100
	100X100	1	1,00	27,88	48	48,00	1.338
	75X75	2	1,11	25,55	42	46,62	1.073
	60X120	2	1,44	35,04	27	38,88	946
Koen	60X60	4	1,44	32,93	30	43,20	988
	30X120	3	1,06	22,80	40	42,40	912
Oregón	20X120	4	0,96	23,58	48	46,08	1.132
	20X120	4	0,96	20,02	48	46,08	960
Pierre de Bali	Oxford	5	1,10	24,43	40	44,00	977
	30X60	8	1,44	27,23	40	57,60	1.089
Triana	15X15	22	0,50	8,95	120	59,40	1.074
	20X120	4	0,96	21,13	48	46,08	1.014
Vita	120X120	1	1,44	36,11	36	51,84	1.300
	60X120	2	1,44	36,91	32	46,08	1.181
	60X60	4	1,44	31,43	30	43,20	943
	30X60	6	1,08	23,48	48	51,84	1.127
Wabi Sabi	120X120	1	1,44	37,69	36	51,84	1.357
	60X120	2	1,44	33,91	32	46,08	1.085
	60X60	4	1,44	31,03	30	43,20	931
	30X60	6	1,08	22,81	48	51,84	1.095
	75X75	2	1,13	25,33	48	54,24	1.216
Work	20X120	4	0,96	20,65	48	46,08	991
	120X120	1	1,44	32,28	36	51,84	1.162
	60X120	2	1,44	28,33	36	51,84	1.020
	60X60	3	1,08	21,88	40	43,20	875
	30X60	6	1,08	21,44	48	51,84	1.029
	90X90	2	1,62	36,21	24	38,88	869
	30X120	3	1,08	23,06	48	51,84	1.107
20X120	3	0,72	15,30	60	43,20	918	
	21X18,2	16	0,46	9,78	100	45,86	978

TECHNICAL SERVICE /
SERVICIO TÉCNICO

Technical support & Information services for APE Distributors, Architects, Engineers and contractors, to provide technical assistance:

- Products specifications and choice criteria
- AutoCAD 3D design service
- Architectural details and design proposals
- Determination of quantities
- Technical information, product tests and certificates
- Job site support and post-installation service
- Technical reports and installation suggestions

El Dpto. de Asistencia Técnica de APE, está a disposición de Técnicos Prescriptores, Dirección Facultativa y Distribuidores, para ofrecerles soporte técnico sobre:

- Especificación de productos y criterio de selección
- Servicio de diseño AutoCAD 3D
- Detalles constructivos y propuestas de diseño
- Despieces y Mediciones
- Documentación técnica, fichas, ensayos y certificados
- Asistencia técnica en obra y servicio post-venta
- Informes y recomendaciones de instalación

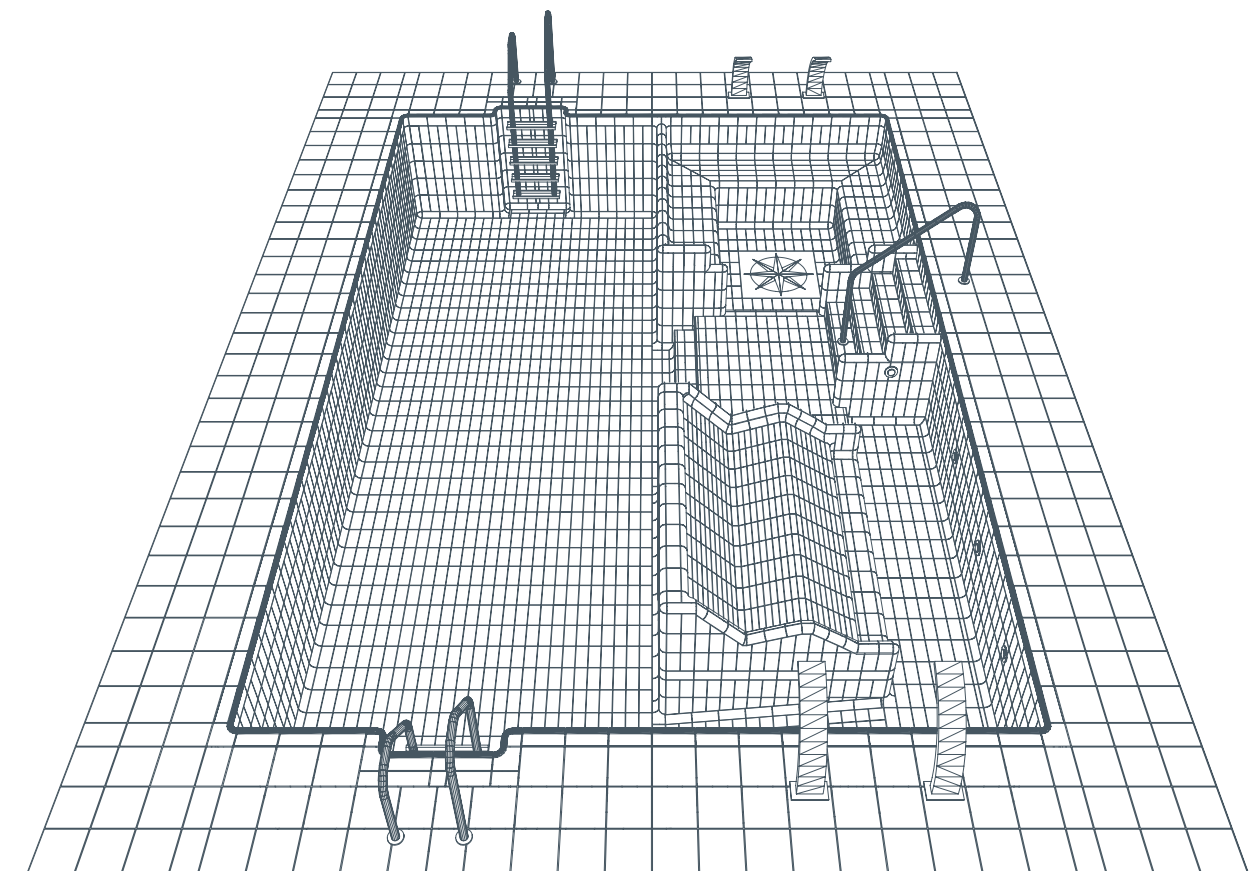

La reproducción de los colores es aproximada. Ape grupo se reserva el derecho de alterar o modificar los productos aquí relacionados.

The reproduction of the colours is approximate. Ape grupo reserves the right to alter or amend the products here stated.

**Los códigos de precios y referencias deben verificarse ya que puede haber errores tipográficos.
Es recomendable consultar la web ya que cualquier producto de ese catálogo puede sufrir cambios en códigos de venta, formatos, packing,.**

*Price codes and product codes should be checked, since there may be typographical errors.
We always recommend consulting the website as the products could undergo price code, format or packing changes.*

En la web también pueden consultar las características técnicas, consejos de colocación , elementos de merchandising o los diversos ambientes de cada una de las colecciones.

On the website you can also find the technical specifications, installation suggestions, merchandising elements and a variety of room scene pictures for each of the collections.